



# LM-79 Test Report

## **Relevant Standards**

IES LM-79-2008  
IES TM-30-2015  
CIE 13.3-1995  
IESNA TM-15-11  
CIE 117:1995

## **Product SKU**

STREAMLITE™ LED Tape Light  
DI-24V-STMLT1-30

## **Test Conditions**

Test Temperature: 26.5 °C  
Luminaire Sample Length: 1000 mm.  
Power Supply: Agilent E3634A DC Power Supply  
Voltage: 24.0 VDC  
Current: 0.204 A  
Power Consumption: 4.9 W

## **Test Date**

12/30/2025

**Color Details**

Correlated Color Temperature	CCT = 2908
CIE Test Color Method General Index	CRI = 94.5
CIE Test Color Method Sample Nine Score	R9 = 59.6
IES TM-30-15 Fidelity Index	R <sub>f</sub> = 92.9
IES TM-30-15 Gamut Index	R <sub>g</sub> = 100.4
Luminous Flux	Lm = 521

Color coordinates CIE 1931	(x;y) = (0.442;0.403)
Color coordinate CIEs 1960	(u;v) = (0.254;0.348)
Color coordinate CIEs 1976	(u';v') = (0.254;0.522)
Color deviation from BBL	Duv = -0.0011
Color Quality Scale (CQS)	CQS = 92.0

**CIE 1931**

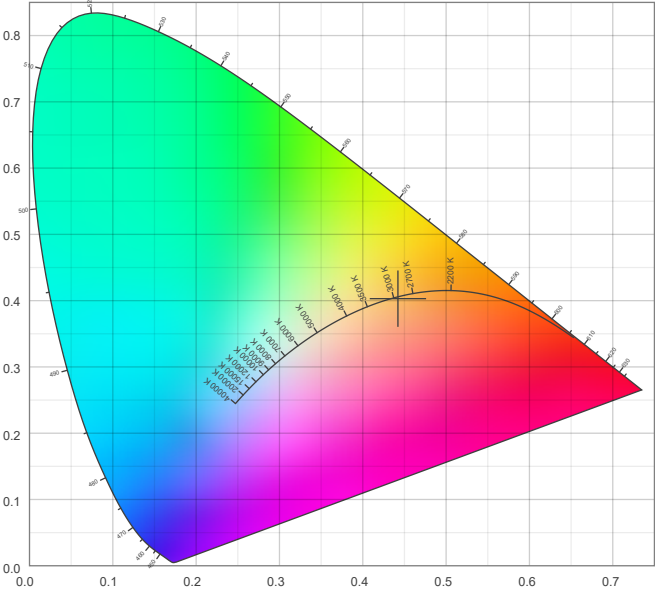

**CIE 1931 – zoomed on Planckian locus**

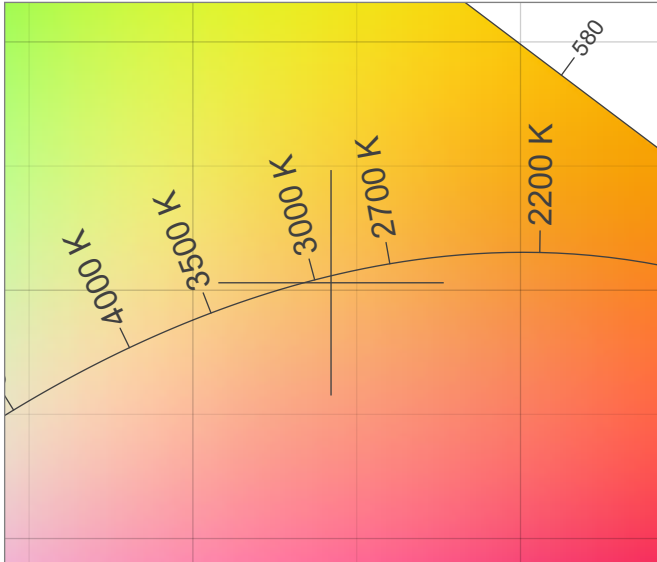

**Color Rendering Index per Reference Color (CIE 1995)**

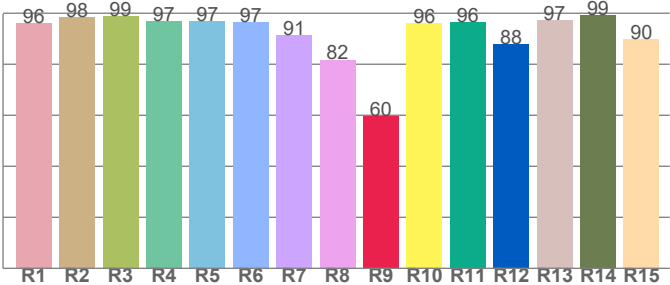

CRI R values, only R1-R8 are used to calculate final CRI value

R1	R2	R3	R4	R5	R6	R7	R8	R9	R10	R11	R12	R13	R14	R15
96.0	98.4	98.8	96.8	96.7	96.5	91.3	81.8	59.6	96.3	96.5	87.7	97.1	99.3	90.0

**Spectral Power Distribution (SPD) / W/nm – 0-100%**

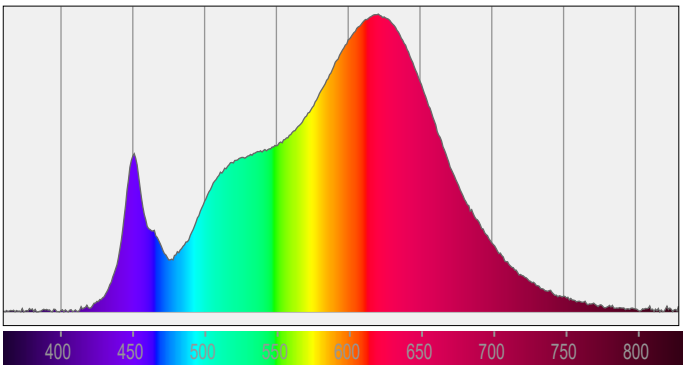

**TM30-18 Rf-Values per Hue Bin**

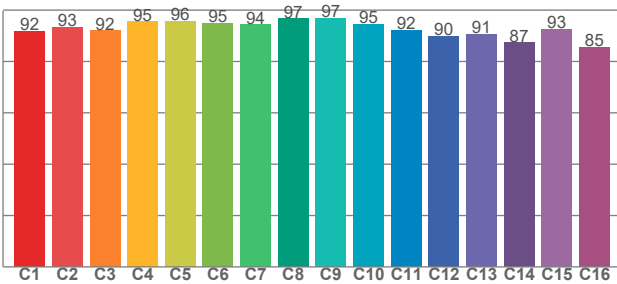

TM30 C values, 16 binned values out of total of 99 C values

C1	C2	C3	C4	C5	C6	C7	C8	C9	C10	C11	C12	C13	C14	C15	C16
91.7	93.4	92.0	95.4	95.6	94.9	94.3	96.7	97.0	94.6	92.1	89.9	90.5	87.3	92.5	85.4

**Color Quality Scale by Reference Color**

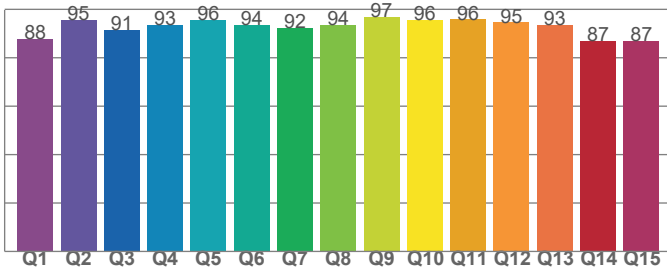

CQS Q values

Q1	Q2	Q3	Q4	Q5	Q6	Q7	Q8	Q9	Q10	Q11	Q12	Q13	Q14	Q15
87.8	95.4	91.4	93.4	95.8	93.6	92.3	93.6	96.7	95.6	95.9	94.6	93.4	87.0	87.0



**Rf 92.9**  
Fidelity index Rf

**Rg 100.4**  
Gamut index Rg

Hue Bin	R <sub>f</sub>	Shifts (%)	
		Chroma	Hue
1	92	-5%	0%
2	93	-3%	2%
3	92	-1%	4%
4	95	-1%	1%
5	96	1%	2%
6	95	3%	1%
7	94	0%	-2%
8	97	2%	-1%
9	97	0%	1%
10	95	0%	3%
11	92	2%	5%
12	90	5%	-1%
13	91	3%	-7%
14	87	3%	-10%
15	93	-1%	-4%
16	85	-3%	-11%

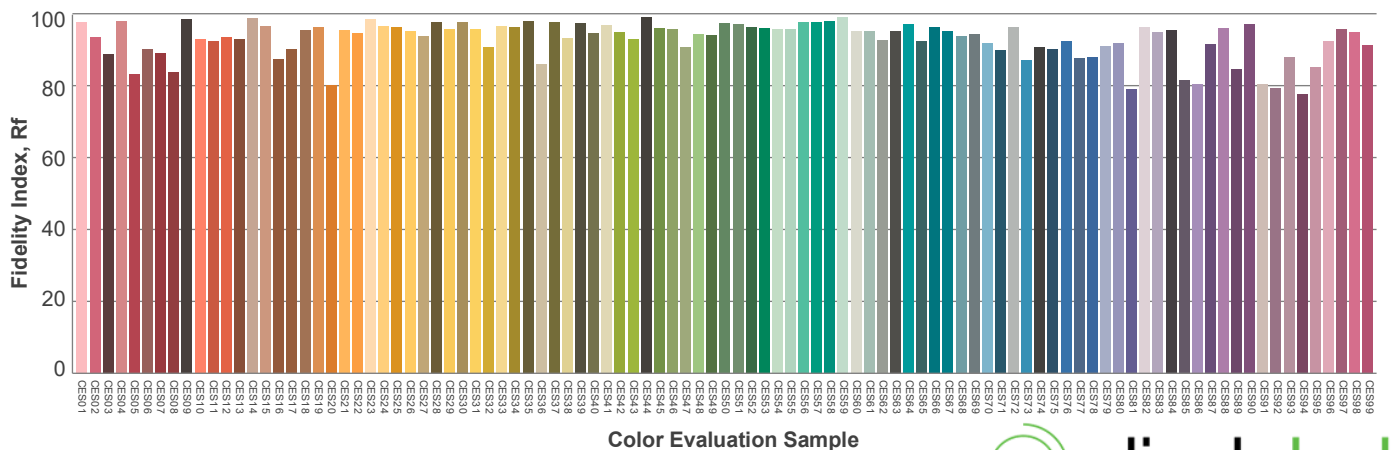
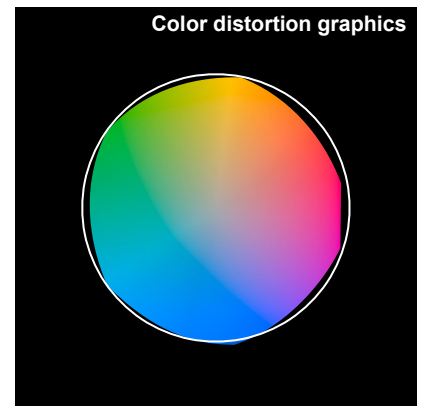
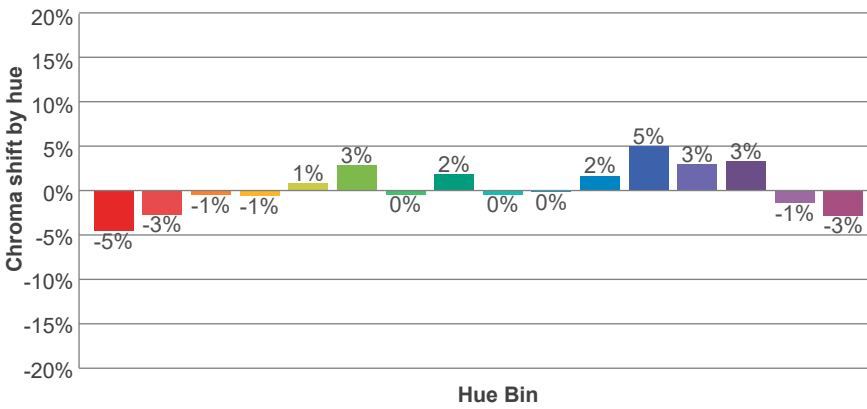
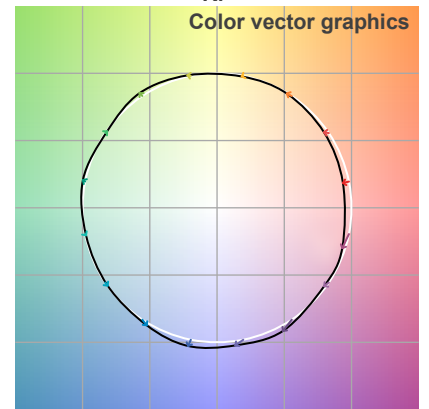
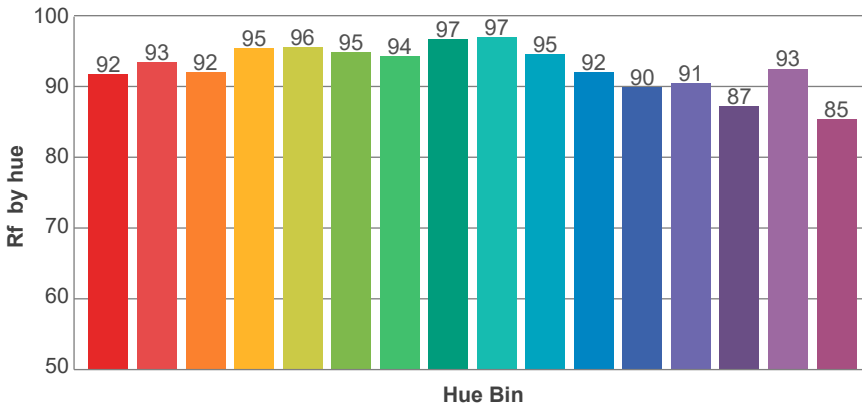
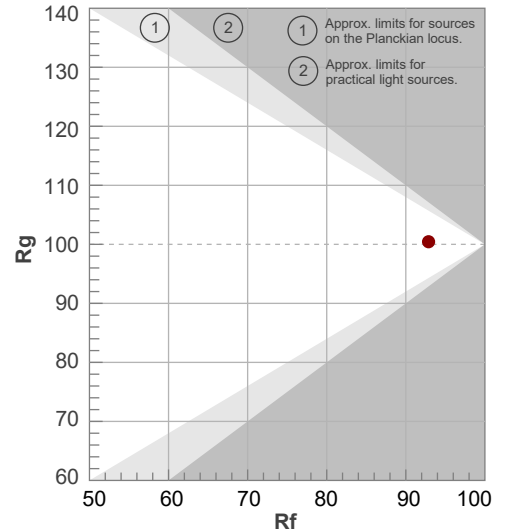

**Beam Details**

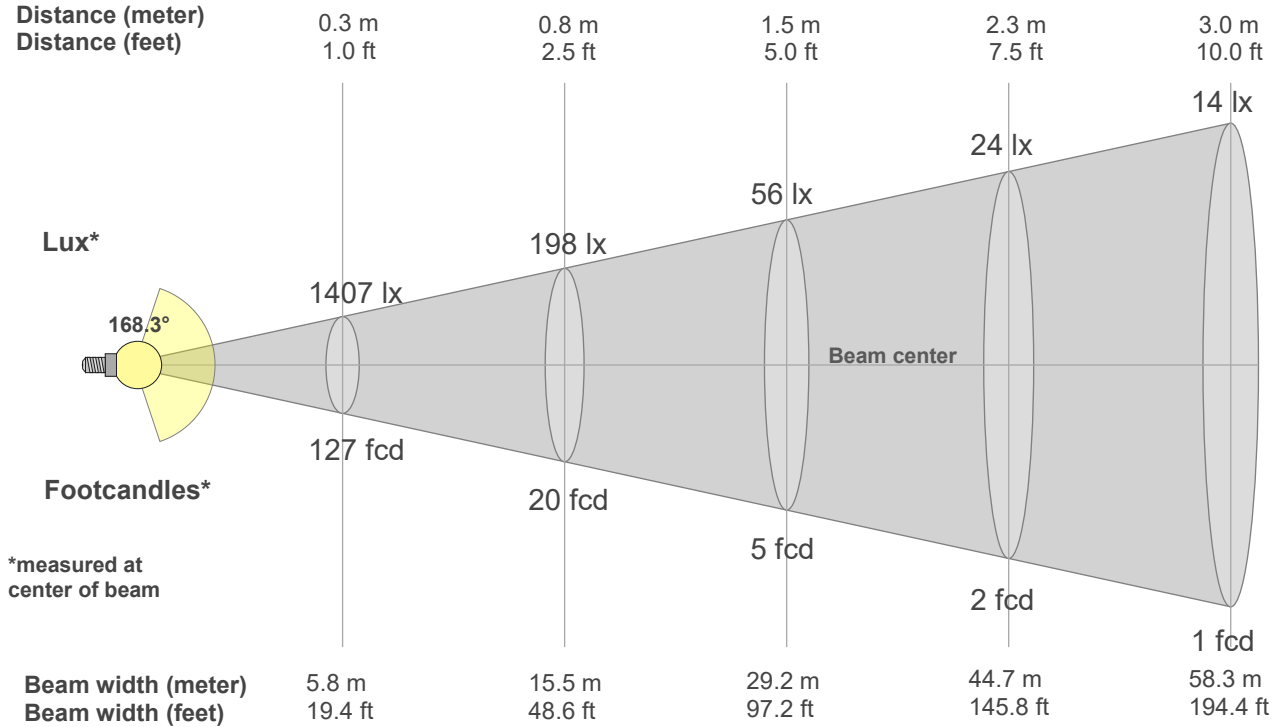

**Beam Intensities from 1-20m**

1m	2m	3m	4m	5m	6m	7m	8m	9m	10m	11m	12m	13m	14m	15m	16m	17m	18m	19m	20m
3.3ft	6.6ft	9.8ft	13.1ft	16.4ft	19.7ft	23ft	26.2ft	29.5ft	32.8ft	36.1ft	39.4ft	42.7ft	45.9ft	49.2ft	52.5ft	55.8ft	59.1ft	62.3ft	65.6ft
127lx	32lx	14lx	8lx	5lx	4lx	3lx	2lx	2lx	1lx	1lx	1lx	1lx	1lx	1lx	0lx	0lx	0lx	0lx	0lx
11.8fcd	2.9fcd	1.3fcd	0.7fcd	0.5fcd	0.3fcd	0.2fcd	0.2fcd	0.1fcd	0.1fcd	0.1fcd	0.1fcd	0.1fcd	0.1fcd	0.1fcd	0fcd	0fcd	0fcd	0fcd	0fcd

**Intensities in 0° c-plane**

0°	9°	18°	27°	36°	45°	54°	63°	72°	81°	90°	99°	108°	117°	126°	135°	144°	153°	162°	171°
127	126	123	118	112	104	96	87	79	68	27	0	0	0	0	0	0	0	0	0
100%	99%	97%	93%	88%	82%	76%	69%	62%	54%	21%	0%	0%	0%	0%	0%	0%	0%	0%	0%

**Intensities in 90° c-plane**

0°	9°	18°	27°	36°	45°	54°	63°	72°	81°	90°	99°	108°	117°	126°	135°	144°	153°	162°	171°
127	125	120	113	102	88	73	54	34	15	1	0	0	0	0	0	0	0	0	0
100%	99%	95%	89%	81%	70%	57%	43%	27%	12%	1%	0%	0%	0%	0%	0%	0%	0%	0%	0%

**Intensities in 180° c-plane**

0°	9°	18°	27°	36°	45°	54°	63°	72°	81°	90°	99°	108°	117°	126°	135°	144°	153°	162°	171°
127	126	123	118	112	104	96	87	79	68	27	0	0	0	0	0	0	0	0	0
100%	99%	97%	93%	88%	82%	76%	69%	62%	54%	21%	0%	0%	0%	0%	0%	0%	0%	0%	0%

**Intensities in 270° c-plane**

0°	9°	18°	27°	36°	45°	54°	63°	72°	81°	90°	99°	108°	117°	126°	135°	144°	153°	162°	171°
127	125	120	113	102	88	73	54	34	15	1	0	0	0	0	0	0	0	0	0
100%	99%	95%	89%	81%	70%	57%	43%	27%	12%	1%	0%	0%	0%	0%	0%	0%	0%	0%	0%

Beam angle 50%	Field angle 10%	Cutoff angle 2,5%	Intensity ratio in 120° cone	Intensity ratio in 90° cone
143.2°	206.1°	215.8°	61.1%	39.5%



### Luminous Intensity Diagram

Unit: 0-100% of peak intensity

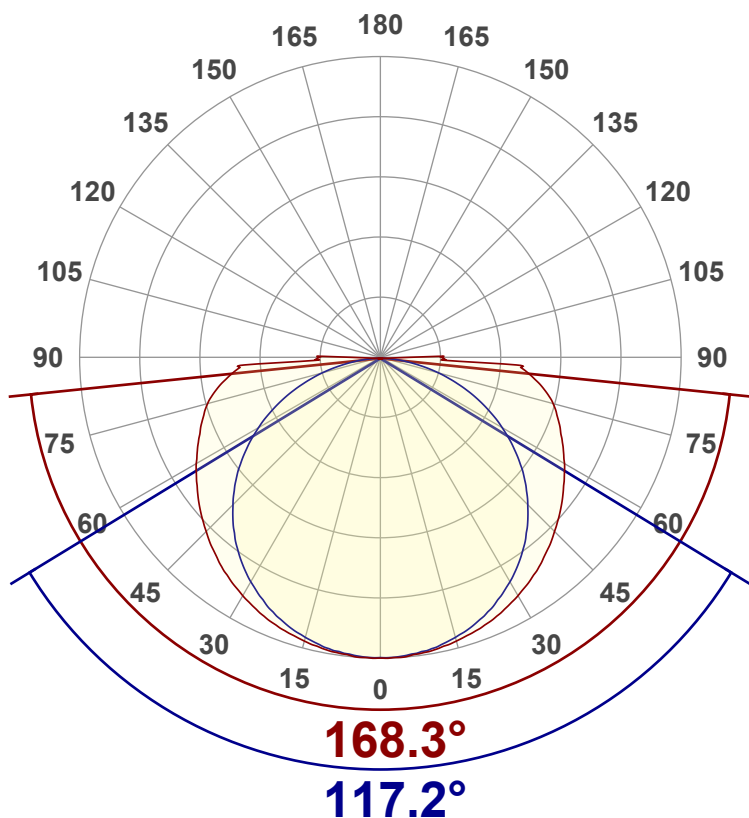

### Main Values

Output (Total Lumen)	521 lm
Lumen Up% / Down%	6.44% / 93.56%
Peak Intensity	127 cd
Beam Angle (50%)	143.2°
Beam Angle (90%)	117.2°
Beam Angle (10%)	168.3°

### Cut-off Angle

Average 2,5%	215.8°
--------------	--------

### Field Angle

Average 10%	206.1°
-------------	--------

### Intensity Ratio

In 120° cone	61.1%
In 90° cone	39.5%

**C000-C180**   **C090-C270**

### Zonal Lumen Summary

0°-10°	10°-20°	20°-30°	30°-40°	40°-50°	50°-60°	60°-70°	70°-80°	80°-90°
12.0 lm	34.8 lm	54.0 lm	67.8 lm	74.8 lm	74.9 lm	69.1 lm	59.1 lm	40.6 lm
90°-100°	100°-110°	110°-120°	120°-130°	130°-140°	140°-150°	150°-160°	160°-170°	170°-180°
14.6 lm	4.04 lm	3.58 lm	3.23 lm	2.79 lm	2.26 lm	1.67 lm	1.02 lm	0.344 lm

LCS Table

BUG rating:	B0 U0 G1	
<b>Forward light</b>	Lumens	Lumens %
Low(0-30):	53.9	10.3%
Medium(30-60):	116.2	22.3%
High(60-80):	68.5	13.2%
Very high(80-90):	21.2	4.1%
<b>Back light</b>		
Low(0-30):	53.9	10.3%
Medium(30-60):	116.2	22.3%
High(60-80):	68.5	13.2%
Very high(80-90):	22	4.2%
<b>Uplight</b>		
Low(90-100):	0	0%
High(100-180):	0	0%

LCS Graph

