

# LM-79 Test Report

## Relevant Standards

IES LM-79-2008  
IES TM-30-2015  
CIE 13.3-1995  
IESNA TM-15-11  
CIE 117:1995

## Product SKU

VALENT® MINI 10MM LED Tape Light  
DI-24V-VL10MN5-40

## Test Conditions

Test Temperature: 26.5 °C  
Luminaire Sample Length: 1000 mm.  
Power Supply: Agilent E3634A DC Power Supply  
Voltage: 24.0 VDC  
Current: 0.614 A  
Power Consumption: 14.7 W

## Test Date

10/21/2025

**Color Details**

Correlated Color Temperature	CCT = 4010
CIE Test Color Method General Index	CRI = 91.1
CIE Test Color Method Sample Nine Score	R9 = 52.0
IES TM-30-15 Fidelity Index	R <sub>f</sub> = 86.7
IES TM-30-15 Gamut Index	R <sub>g</sub> = 93.8
Luminous Flux	Lm = 2368

Color coordinates CIE 1931	(x;y) = (0.382;0.382)
Color coordinate CIEs 1960	(u;v) = (0.224;0.336)
Color coordinate CIEs 1976	(u';v') = (0.224;0.504)
Color deviation from BBL	Duv = 0.0022
Color Quality Scale (CQS)	CQS = 89.7

**CIE 1931**

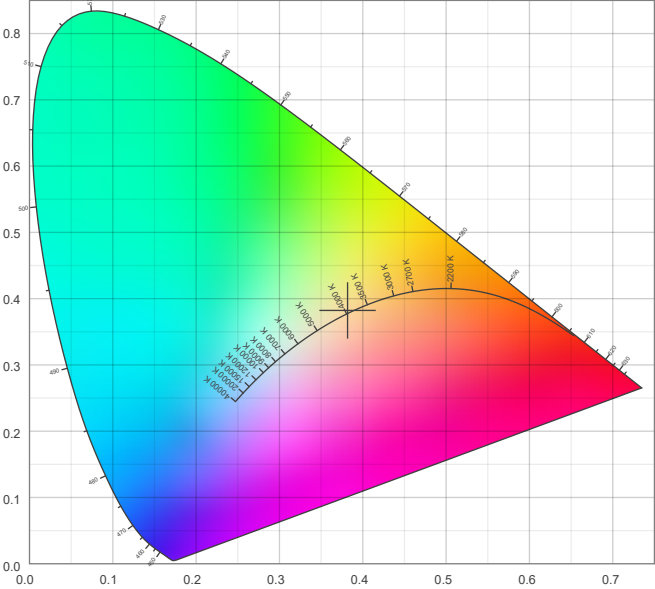

**CIE 1931 – zoomed on Planckian locus**

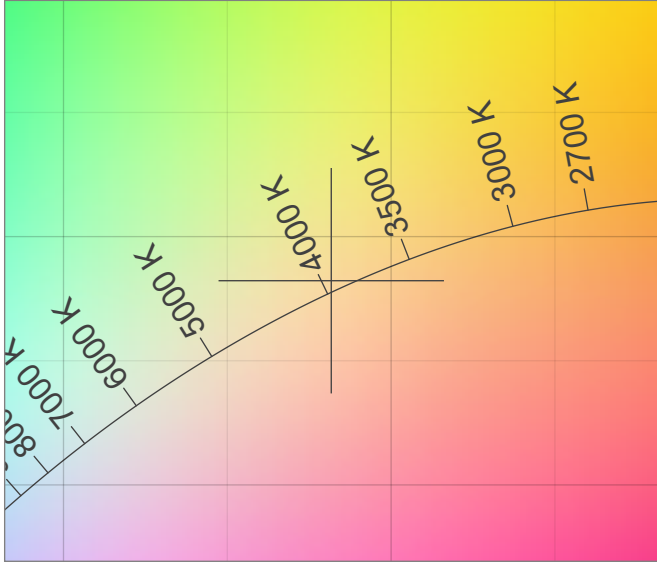

**Color Rendering Index per Reference Color (CIE 1995)**

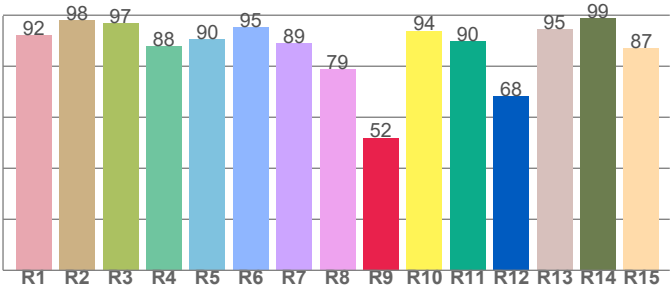

CRI R values, only R1-R8 are used to calculate final CRI value

R1	R2	R3	R4	R5	R6	R7	R8	R9	R10	R11	R12	R13	R14	R15
92.3	98.0	96.9	88.0	90.4	95.2	88.9	79.0	52.0	93.9	89.8	68.3	94.6	98.9	86.9

**Spectral Power Distribution (SPD) / W/nm – 0-100%**

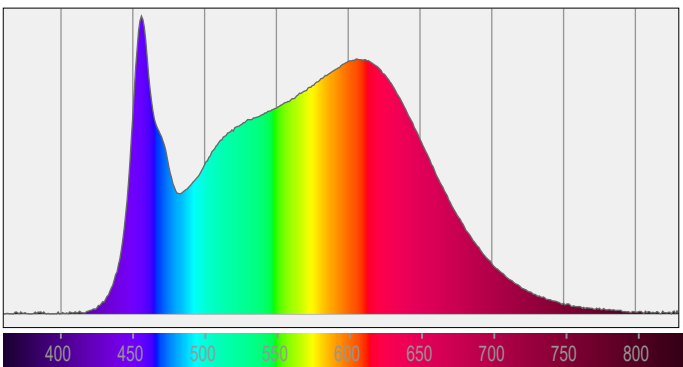

**TM30-18 Rf-Values per Hue Bin**

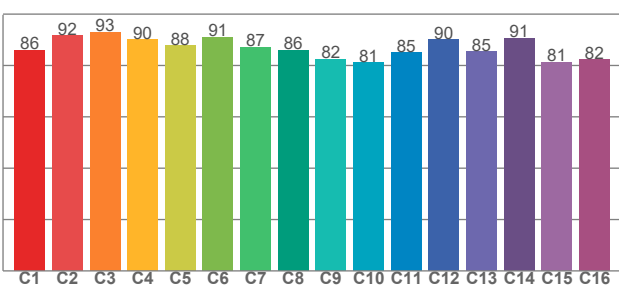

TM30 C values, 16 binned values out of total of 99 C values

C1	C2	C3	C4	C5	C6	C7	C8	C9	C10	C11	C12	C13	C14	C15	C16
85.8	91.5	92.9	90.0	87.6	91.0	87.1	86.0	82.4	81.0	84.9	90.0	85.4	90.5	81.3	82.2

**Color Quality Scale by Reference Color**

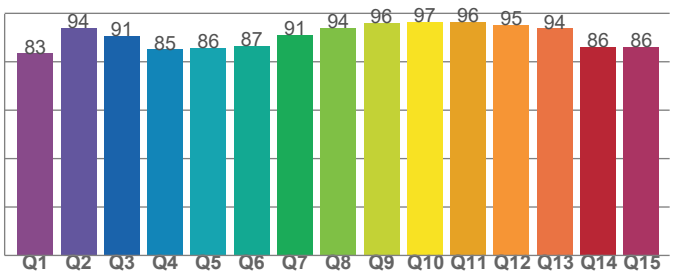

CQS Q values

Q1	Q2	Q3	Q4	Q5	Q6	Q7	Q8	Q9	Q10	Q11	Q12	Q13	Q14	Q15
83.4	93.8	90.8	85.1	85.8	86.7	91.1	93.9	96.1	96.6	96.5	95.2	93.8	86.1	86.0



**Rf 86.7**  
Fidelity index Rf

**Rg 93.8**  
Gamut index Rg

Hue Bin	R <sub>f</sub>	Shifts (%)	
		Chroma	Hue
1	86	-7%	2%
2	92	-3%	2%
3	93	-3%	1%
4	90	-5%	-3%
5	88	-9%	-2%
6	91	-6%	0%
7	87	-8%	4%
8	86	-5%	7%
9	82	-2%	13%
10	81	0%	12%
11	85	6%	8%
12	90	4%	-1%
13	85	2%	-10%
14	91	-1%	-6%
15	81	-3%	-11%
16	82	-4%	-7%

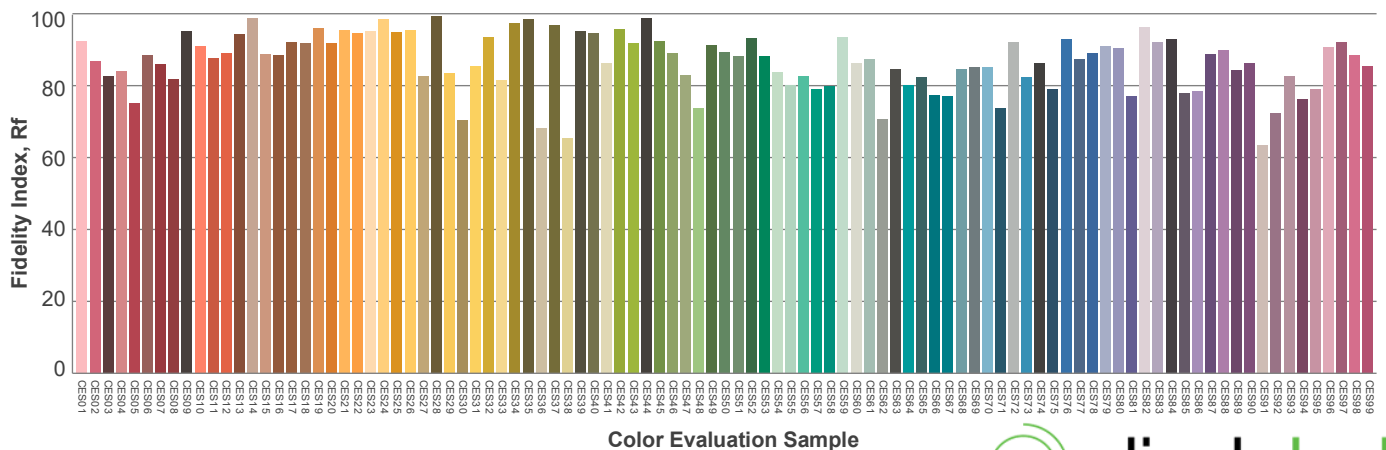
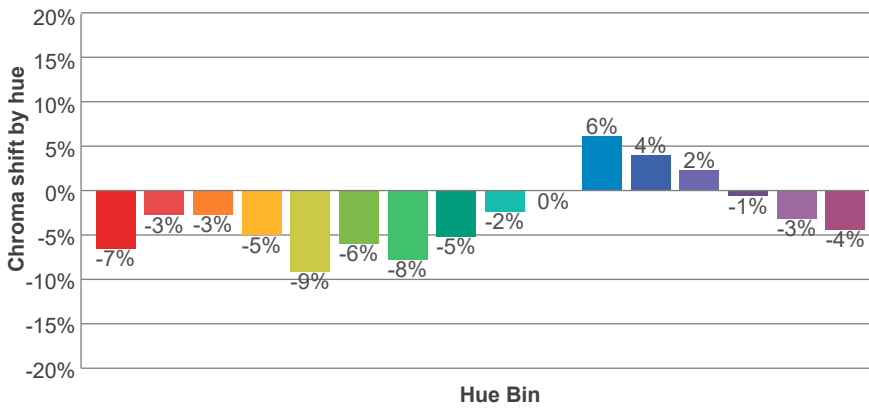
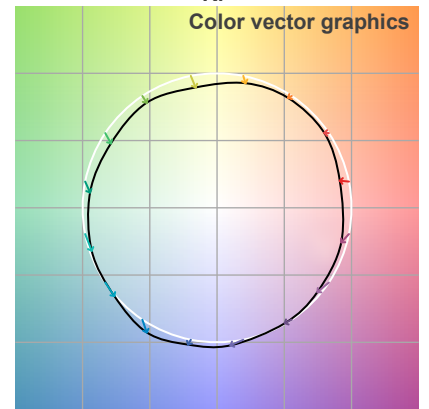
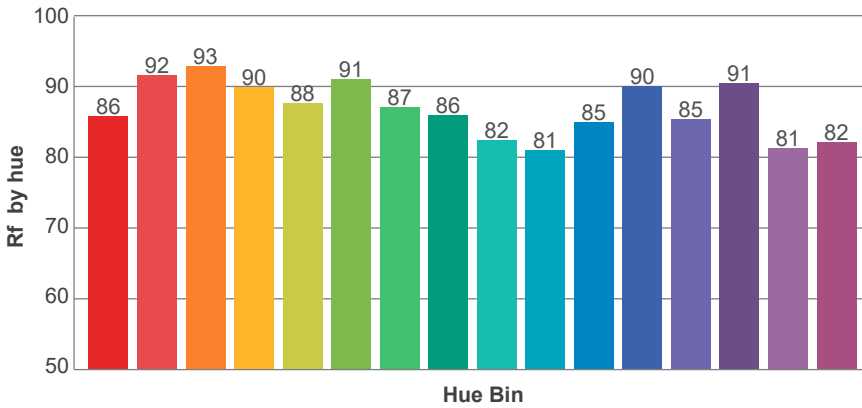
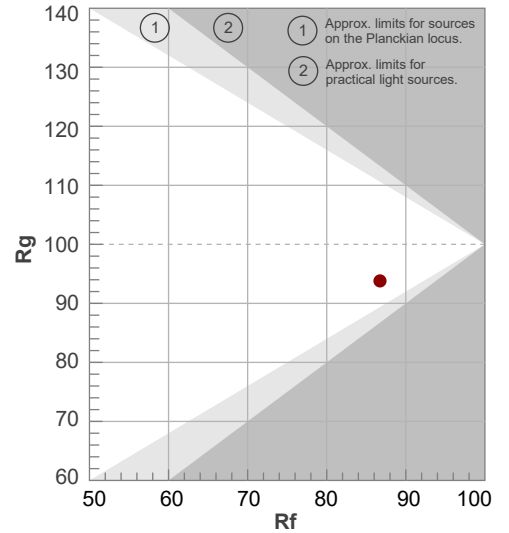

**Beam Details**

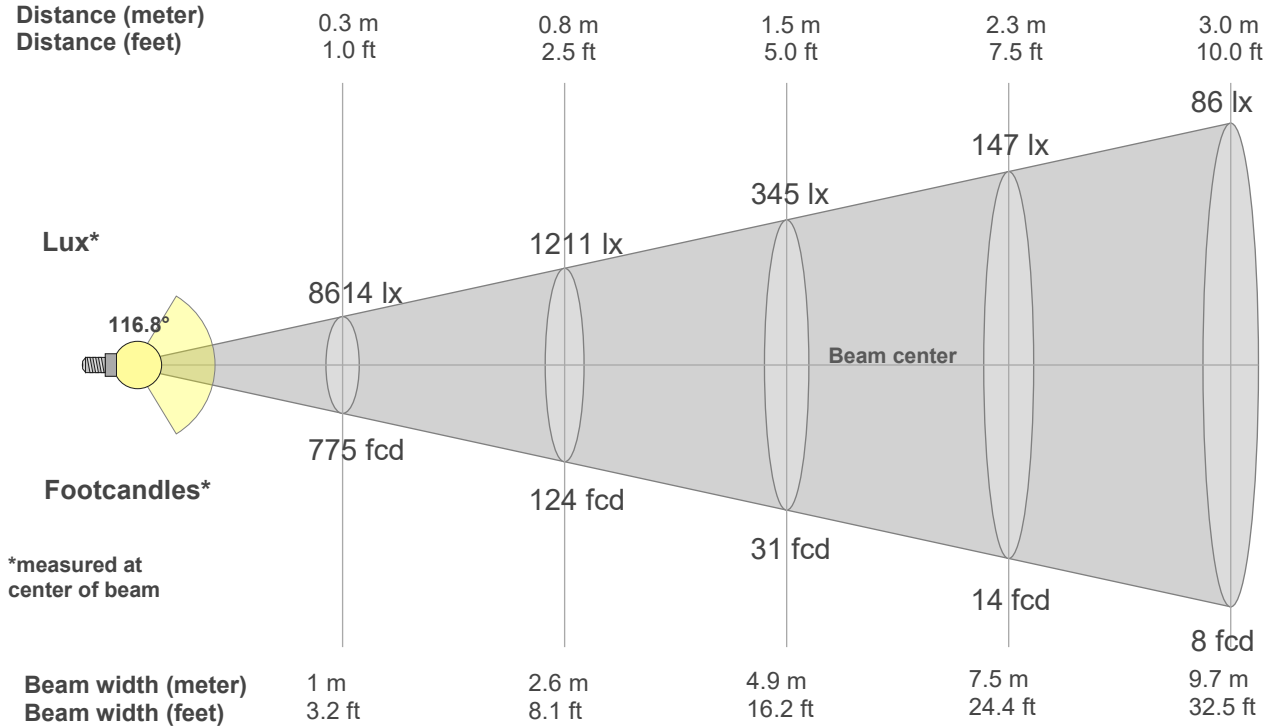

\*measured at center of beam

**Beam Intensities from 1-20m**

1m	2m	3m	4m	5m	6m	7m	8m	9m	10m	11m	12m	13m	14m	15m	16m	17m	18m	19m	20m
3.3ft	6.6ft	9.8ft	13.1ft	16.4ft	19.7ft	23ft	26.2ft	29.5ft	32.8ft	36.1ft	39.4ft	42.7ft	45.9ft	49.2ft	52.5ft	55.8ft	59.1ft	62.3ft	65.6ft
775lx	194lx	86lx	48lx	31lx	22lx	16lx	12lx	10lx	8lx	6lx	5lx	5lx	4lx	3lx	3lx	3lx	2lx	2lx	2lx
72fcd	18fcd	8fcd	4.5fcd	2.9fcd	2fcd	1.5fcd	1.1fcd	0.9fcd	0.7fcd	0.6fcd	0.5fcd	0.4fcd	0.4fcd	0.3fcd	0.3fcd	0.2fcd	0.2fcd	0.2fcd	0.2fcd

**Intensities in 0° c-plane**

0°	5°	10°	15°	20°	25°	30°	35°	40°	45°	50°	55°	60°	65°	70°	75°	80°	85°	90°	95°
775	773	764	749	728	702	670	633	589	541	487	429	367	302	234	165	100	48	11	10
100%	100%	99%	97%	94%	91%	86%	82%	76%	70%	63%	55%	47%	39%	30%	21%	13%	6%	1%	1%

**Intensities in 90° c-plane**

0°	5°	10°	15°	20°	25°	30°	35°	40°	45°	50°	55°	60°	65°	70°	75°	80°	85°	90°	95°
775	772	764	750	730	705	674	638	596	549	496	438	375	308	237	165	96	40	4	0
100%	100%	99%	97%	94%	91%	87%	82%	77%	71%	64%	56%	48%	40%	31%	21%	12%	5%	1%	0%

**Intensities in 180° c-plane**

0°	5°	10°	15°	20°	25°	30°	35°	40°	45°	50°	55°	60°	65°	70°	75°	80°	85°	90°	95°
775	773	764	749	728	702	670	633	589	541	487	429	367	302	234	165	100	48	11	10
100%	100%	99%	97%	94%	91%	86%	82%	76%	70%	63%	55%	47%	39%	30%	21%	13%	6%	1%	1%

**Intensities in 270° c-plane**

0°	5°	10°	15°	20°	25°	30°	35°	40°	45°	50°	55°	60°	65°	70°	75°	80°	85°	90°	95°
775	772	764	750	730	705	674	638	596	549	496	438	375	308	237	165	96	40	4	0
100%	100%	99%	97%	94%	91%	87%	82%	77%	71%	64%	56%	48%	40%	31%	21%	12%	5%	1%	0%

Beam angle 50%	Field angle 10%	Cutoff angle 2,5%	Intensity ratio in 120° cone	Intensity ratio in 90° cone
<b>117.5°</b>	<b>163.6°</b>	<b>176.8°</b>	<b>76.7%</b>	<b>51.4%</b>



**Luminous Intensity Diagram**

Unit: 0-100% of peak intensity

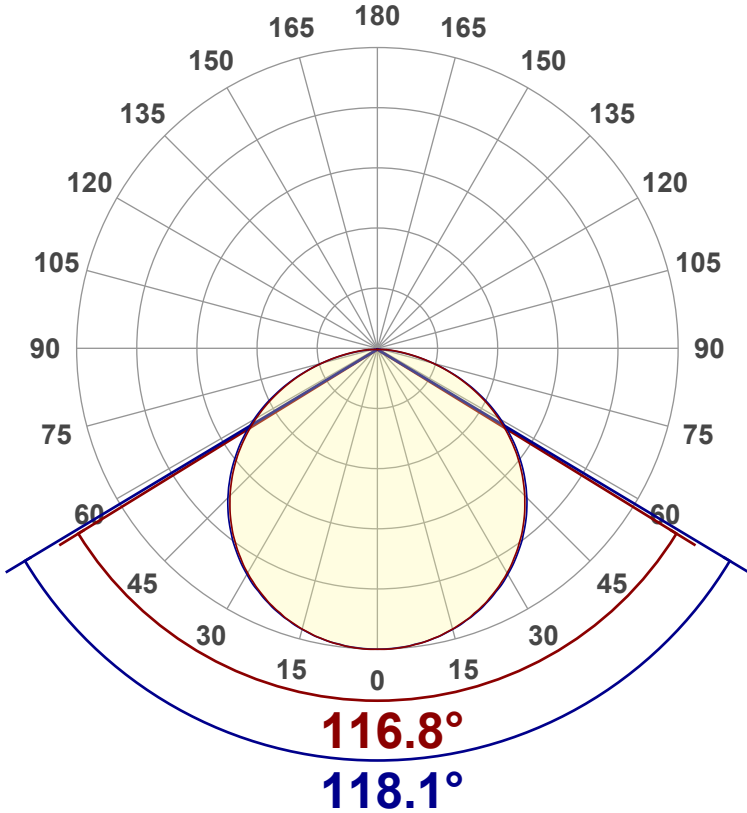

**Main Values**

Output (Total Lumen)	2368 lm
Lumen Up% / Down%	0.99% / 99.01%
Peak Intensity	776 cd
Beam Angle (50%)	117.5°
Beam Angle (90%)	118.1°
Beam Angle (10%)	116.8°

**Cut-off Angle**

Average 2,5%	176.8°
--------------	--------

**Field Angle**

Average 10%	163.6°
-------------	--------

**Intensity Ratio**

In 120° cone	76.7%
In 90° cone	51.4%

**C000-C180 C090-C270**

**Zonal Lumen Summary**

0°-10°	10°-20°	20°-30°	30°-40°	40°-50°	50°-60°	60°-70°	70°-80°	80°-90°
73.5 lm	212 lm	325 lm	398 lm	420 lm	388 lm	301 lm	175 lm	52.4 lm
90°-100°	100°-110°	110°-120°	120°-130°	130°-140°	140°-150°	150°-160°	160°-170°	170°-180°
8.69 lm	3.82 lm	3.28 lm	2.96 lm	1.91 lm	1.20 lm	0.882 lm	0.540 lm	0.182 lm



LCS Table

BUG rating:	B1 U0 G1	
<b>Forward light</b>	Lumens	Lumens %
Low(0-30):	307.9	13%
Medium(30-60):	608.7	25.7%
High(60-80):	240.7	10.2%
Very high(80-90):	26.5	1.1%
<b>Back light</b>		
Low(0-30):	307.9	13%
Medium(30-60):	608.7	25.7%
High(60-80):	240.7	10.2%
Very high(80-90):	26.3	1.1%
<b>Uplight</b>		
Low(90-100):	0	0%
High(100-180):	0	0%

LCS Graph

