



LM-79 Test Report

Relevant Standards

IES LM-79-2008
IES TM-30-2015
CIE 13.3-1995
IESNA TM-15-11
CIE 117:1995

Product SKU

VALENT® MINI 8MM LED Tape Light
DI-24V-VL8MN1-20

Test Conditions

Test Temperature: 26.5 °C
Luminaire Sample Length: 1000 mm.
Power Supply: Agilent E3634A DC Power Supply
Voltage: 24.0 VDC
Current: 0.200 A
Power Consumption: 4.8 W

Test Date

10/21/2025

Color Details

Correlated Color Temperature	CCT =	2005
CIE Test Color Method General Index	CRI =	89.7
CIE Test Color Method Sample Nine Score	R9 =	56.1
IES TM-30-15 Fidelity Index	R _f =	87.3
IES TM-30-15 Gamut Index	R _g =	96.8
Luminous Flux	Lm =	522

Color coordinates CIE 1931	(x;y) =	(0.522;0.408)
Color coordinate CIEs 1960	(u;v) =	(0.305;0.357)
Color coordinate CIEs 1976	(u';v') =	(0.305;0.536)
Color deviation from BBL	Duv =	-0.0018
Color Quality Scale (CQS)	CQS =	81.1

CIE 1931

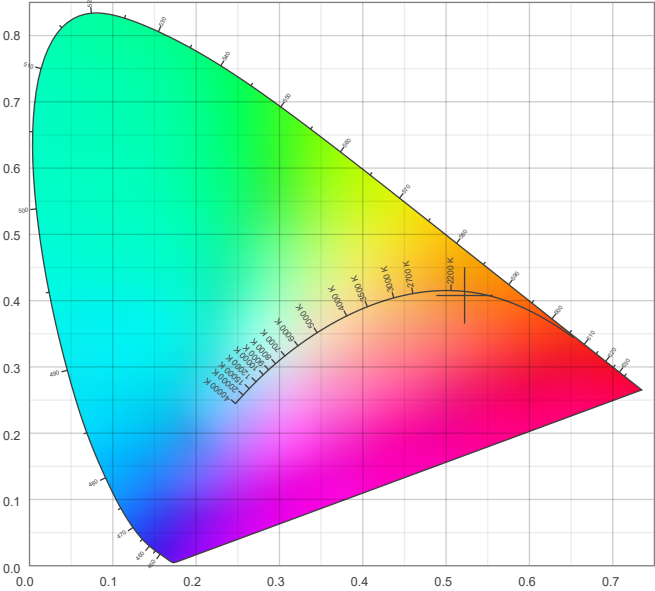

CIE 1931 – zoomed on Planckian locus

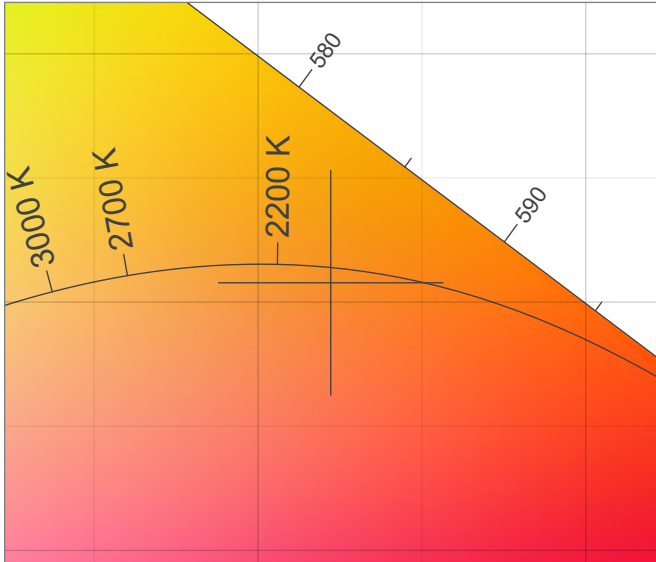

Color Rendering Index per Reference Color (CIE 1995)

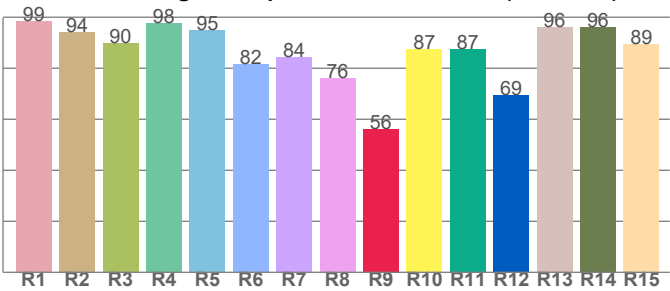

CRI R values, only R1-R8 are used to calculate final CRI value

R1	R2	R3	R4	R5	R6	R7	R8	R9	R10	R11	R12	R13	R14	R15
98.6	94.3	89.9	97.5	95.1	81.7	84.1	75.9	56.1	87.5	87.5	69.4	96.2	95.9	89.4

Spectral Power Distribution (SPD) / W/nm – 0-100%

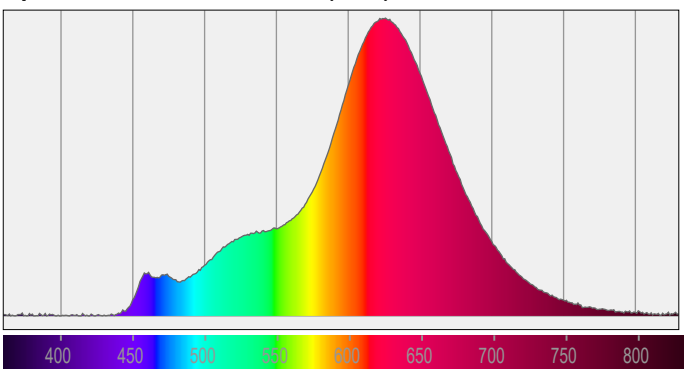

TM30-18 Rf-Values per Hue Bin

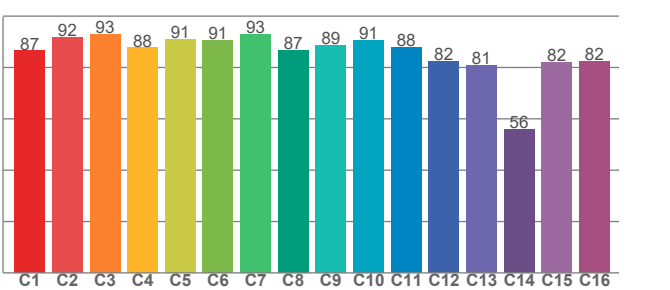

TM30 C values, 16 binned values out of total of 99 C values

C1	C2	C3	C4	C5	C6	C7	C8	C9	C10	C11	C12	C13	C14	C15	C16
86.5	91.7	93.0	87.7	91.0	90.7	92.9	86.7	88.5	90.7	87.8	82.3	80.9	56.0	82.2	82.4

Color Quality Scale by Reference Color

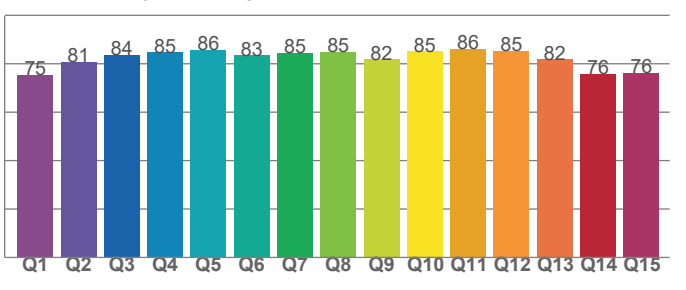

CQS Q values

Q1	Q2	Q3	Q4	Q5	Q6	Q7	Q8	Q9	Q10	Q11	Q12	Q13	Q14	Q15
75.3	80.6	83.5	84.7	85.6	83.4	84.5	85.0	81.8	85.1	86.0	85.3	81.8	75.9	76.2



Rf 87.3
Fidelity index Rf

Rg 96.8
Gamut index Rg

Hue Bin	R _f	Shifts (%)	
		Chroma	Hue
1	87	-5%	4%
2	92	-2%	3%
3	93	1%	-1%
4	88	-6%	-7%
5	91	-6%	-1%
6	91	-3%	4%
7	93	-3%	4%
8	87	2%	8%
9	89	3%	6%
10	91	5%	3%
11	88	8%	-3%
12	82	6%	-11%
13	81	2%	-21%
14	56	-9%	-24%
15	82	-8%	-9%
16	82	-8%	-6%

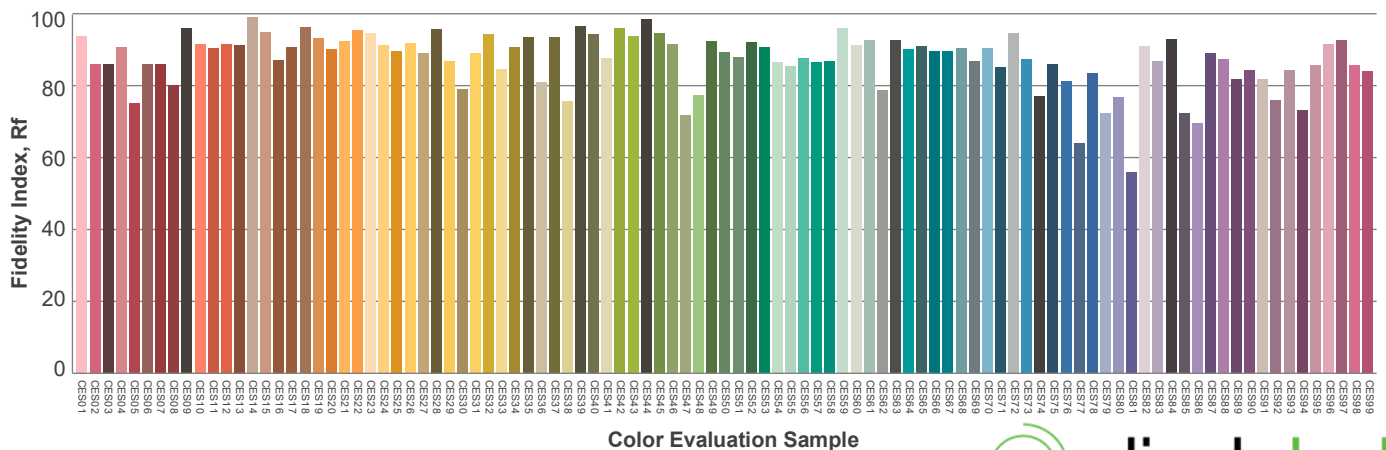
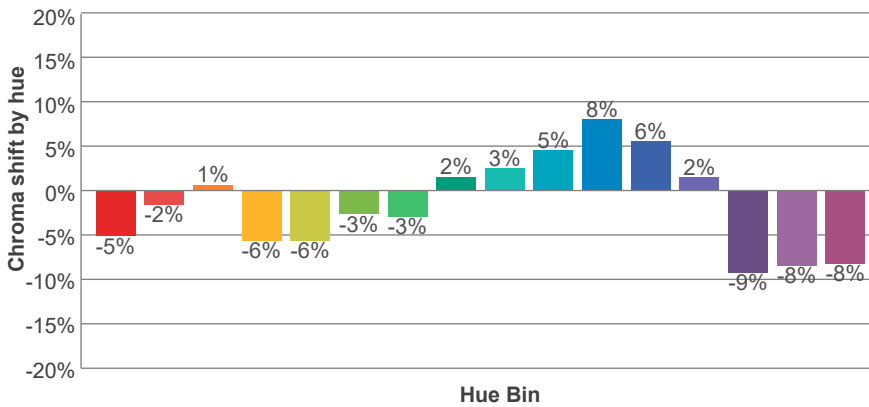
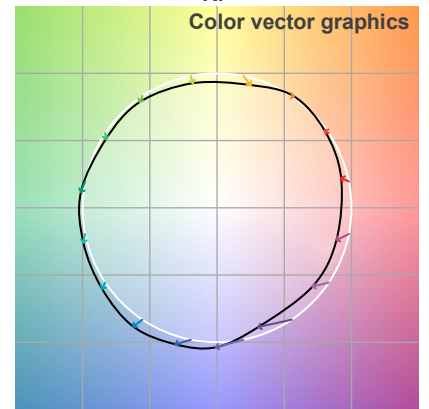
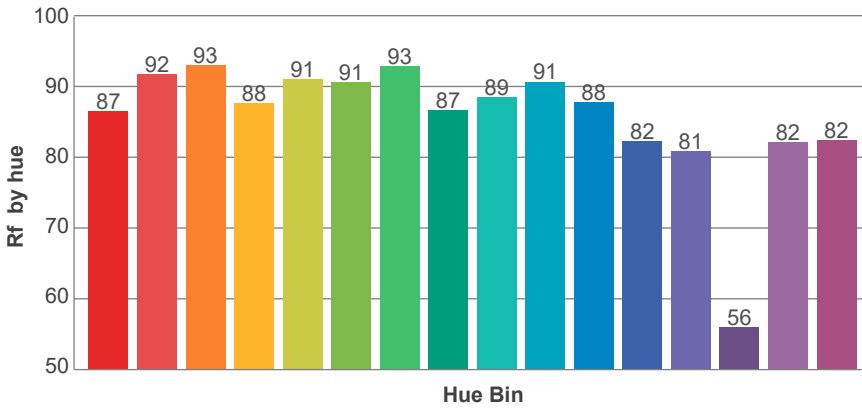
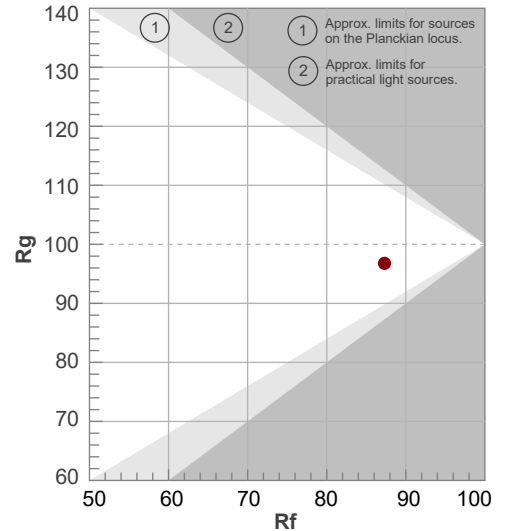

Beam Details

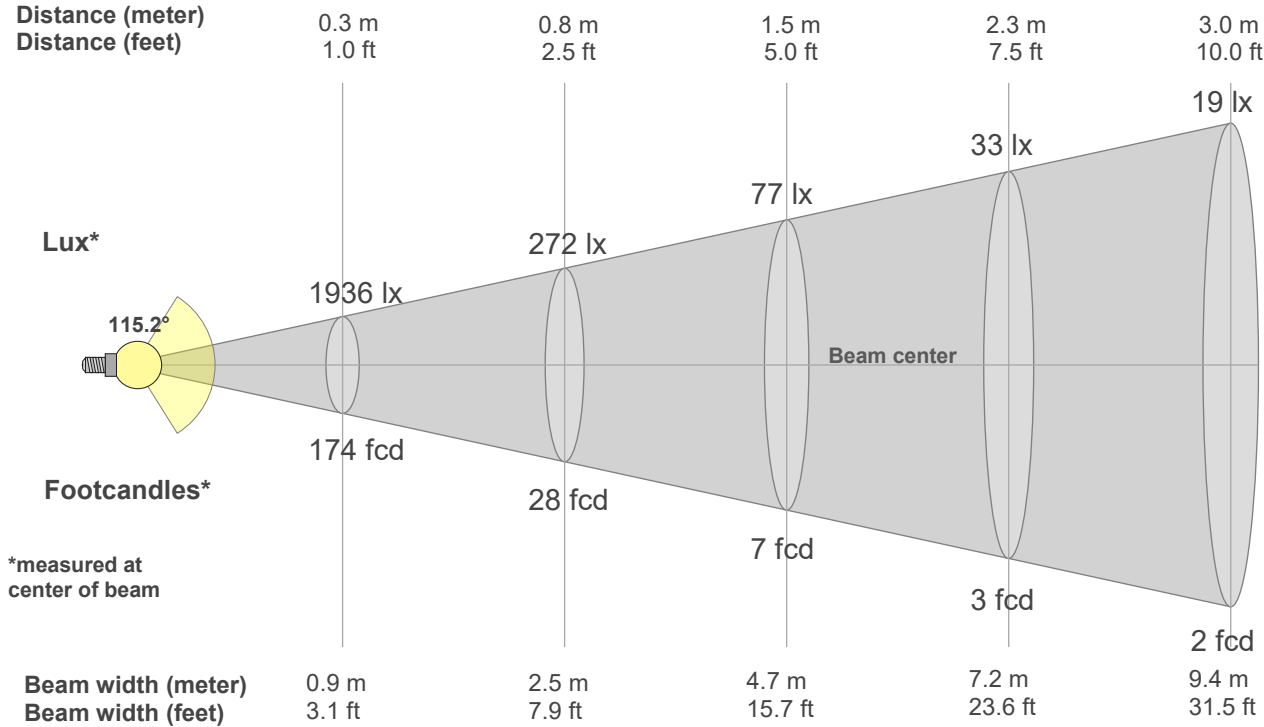

*measured at center of beam

Beam Intensities from 1-20m

1m	2m	3m	4m	5m	6m	7m	8m	9m	10m	11m	12m	13m	14m	15m	16m	17m	18m	19m	20m
3.3ft	6.6ft	9.8ft	13.1ft	16.4ft	19.7ft	23ft	26.2ft	29.5ft	32.8ft	36.1ft	39.4ft	42.7ft	45.9ft	49.2ft	52.5ft	55.8ft	59.1ft	62.3ft	65.6ft
174lx	44lx	19lx	11lx	7lx	5lx	4lx	3lx	2lx	2lx	1lx	1lx	1lx	1lx	1lx	1lx	1lx	1lx	0lx	0lx
16.2fcd	4fcd	1.8fcd	1fcd	0.6fcd	0.4fcd	0.3fcd	0.3fcd	0.2fcd	0.2fcd	0.1fcd	0.1fcd	0.1fcd	0.1fcd	0.1fcd	0.1fcd	0.1fcd	0fcd	0fcd	0fcd

Intensities in 0° c-plane

0°	5°	10°	15°	20°	25°	30°	35°	40°	45°	50°	55°	60°	65°	70°	75°	80°	85°	90°	95°
174	173	171	168	163	157	149	140	130	119	107	94	80	66	51	36	22	10	2	2
100%	100%	98%	96%	94%	90%	86%	81%	75%	68%	62%	54%	46%	38%	29%	20%	12%	6%	1%	1%

Intensities in 90° c-plane

0°	5°	10°	15°	20°	25°	30°	35°	40°	45°	50°	55°	60°	65°	70°	75°	80°	85°	90°	95°
174	173	171	168	163	158	150	142	132	121	109	96	82	67	52	36	21	9	1	1
100%	100%	98%	97%	94%	90%	86%	81%	76%	70%	63%	55%	47%	39%	30%	21%	12%	5%	1%	0%

Intensities in 180° c-plane

0°	5°	10°	15°	20°	25°	30°	35°	40°	45°	50°	55°	60°	65°	70°	75°	80°	85°	90°	95°
174	173	171	168	163	157	149	140	130	119	107	94	80	66	51	36	22	10	2	2
100%	100%	98%	96%	94%	90%	86%	81%	75%	68%	62%	54%	46%	38%	29%	20%	12%	6%	1%	1%

Intensities in 270° c-plane

0°	5°	10°	15°	20°	25°	30°	35°	40°	45°	50°	55°	60°	65°	70°	75°	80°	85°	90°	95°
174	173	171	168	163	158	150	142	132	121	109	96	82	67	52	36	21	9	1	1
100%	100%	98%	97%	94%	90%	86%	81%	76%	70%	63%	55%	47%	39%	30%	21%	12%	5%	1%	0%

Beam angle 50%	Field angle 10%	Cutoff angle 2,5%	Intensity ratio in 120° cone	Intensity ratio in 90° cone
115.8°	163°	176.9°	77.1%	52.0%



Luminous Intensity Diagram

Unit: 0-100% of peak intensity

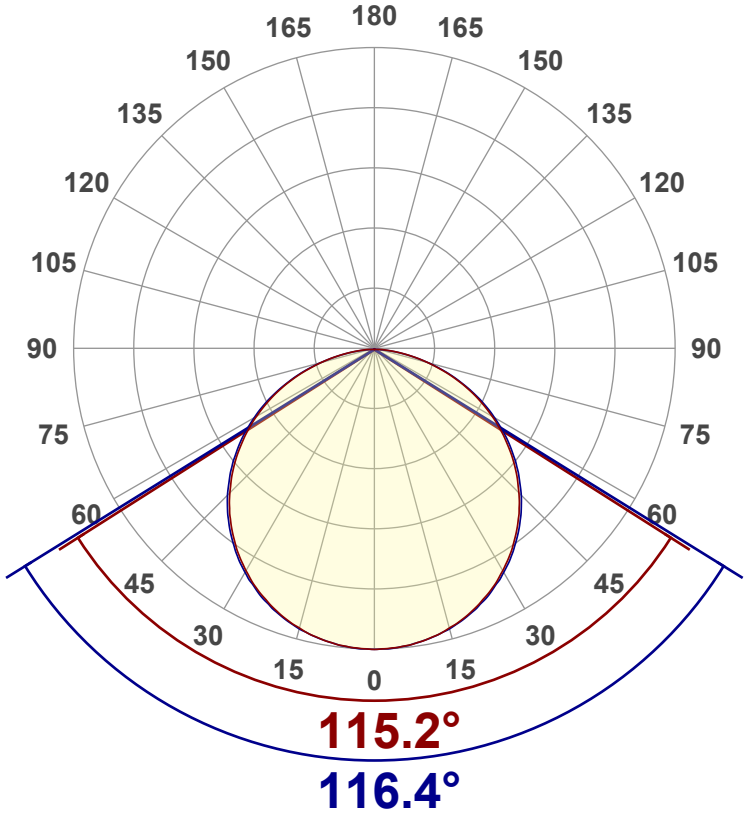

Main Values

Output (Total Lumen)	522 lm
Lumen Up% / Down%	0.88% / 99.12%
Peak Intensity	174 cd
Beam Angle (50%)	115.8°
Beam Angle (90%)	116.4°
Beam Angle (10%)	115.2°

Cut-off Angle

Average 2,5%	176.9°
--------------	--------

Field Angle

Average 10%	163°
-------------	------

Intensity Ratio

In 120° cone	77.1%
In 90° cone	52.0%

C000-C180 C090-C270

Zonal Lumen Summary

0°-10°	10°-20°	20°-30°	30°-40°	40°-50°	50°-60°	60°-70°	70°-80°	80°-90°
16.5 lm	47.4 lm	72.4 lm	88.2 lm	92.7 lm	85.0 lm	65.7 lm	37.9 lm	11.3 lm
90°-100°	100°-110°	110°-120°	120°-130°	130°-140°	140°-150°	150°-160°	160°-170°	170°-180°
1.58 lm	0.821 lm	0.688 lm	0.622 lm	0.386 lm	0.206 lm	0.152 lm	0.093 lm	0.031 lm



LCS Table

BUG rating:	B0 U0 G0	
Forward light	Lumens	Lumens %
Low(0-30):	68.8	13.2%
Medium(30-60):	134.1	25.7%
High(60-80):	52.3	10%
Very high(80-90):	5.7	1.1%
Back light		
Low(0-30):	68.8	13.2%
Medium(30-60):	134.1	25.7%
High(60-80):	52.3	10%
Very high(80-90):	5.7	1.1%
Uplight		
Low(90-100):	0	0%
High(100-180):	0	0%

LCS Graph

