



LM-79 Test Report

Relevant Standards

IES LM-79-2008
IES TM-30-2015
CIE 13.3-1995
IESNA TM-15-11
CIE 117:1995

Product SKU

VALENT® MINI 8MM LED Tape Light
DI-24V-VL8MN1-30

Test Conditions

Test Temperature: 26.5 °C
Luminaire Sample Length: 1000 mm.
Power Supply: Agilent E3634A DC Power Supply
Voltage: 24.0 VDC
Current: 0.200 A
Power Consumption: 4.8 W

Test Date

10/21/2025

Color Details

| | | |
|---|------------------|------|
| Correlated Color Temperature | CCT = | 3022 |
| CIE Test Color Method General Index | CRI = | 92.9 |
| CIE Test Color Method Sample Nine Score | R9 = | 56.6 |
| IES TM-30-15 Fidelity Index | R _f = | 88.4 |
| IES TM-30-15 Gamut Index | R _g = | 95.4 |
| Luminous Flux | Lm = | 675 |

| | | |
|----------------------------|-----------|---------------|
| Color coordinates CIE 1931 | (x;y) = | (0.436;0.403) |
| Color coordinate CIEs 1960 | (u;v) = | (0.250;0.347) |
| Color coordinate CIEs 1976 | (u';v') = | (0.250;0.521) |
| Color deviation from BBL | Duv = | -0.0001 |
| Color Quality Scale (CQS) | CQS = | 90.8 |

CIE 1931

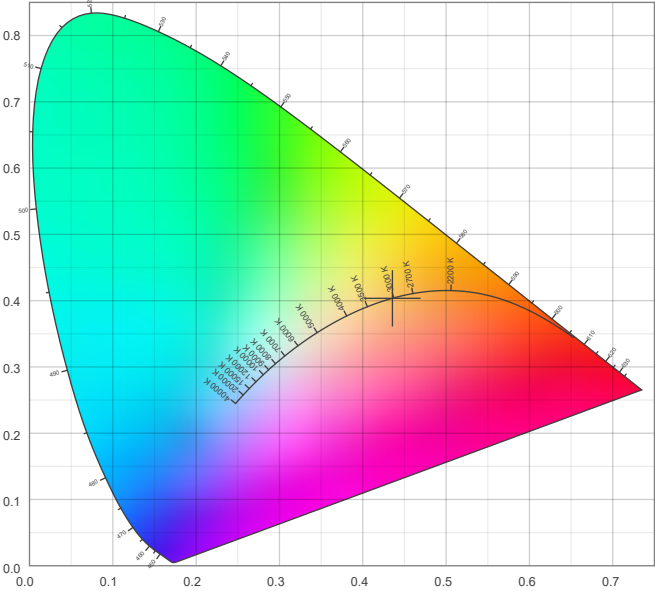

CIE 1931 – zoomed on Planckian locus

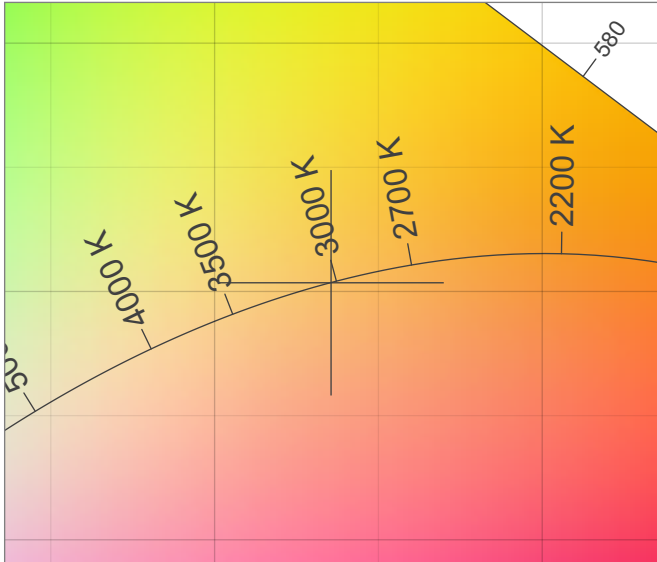

Color Rendering Index per Reference Color (CIE 1995)

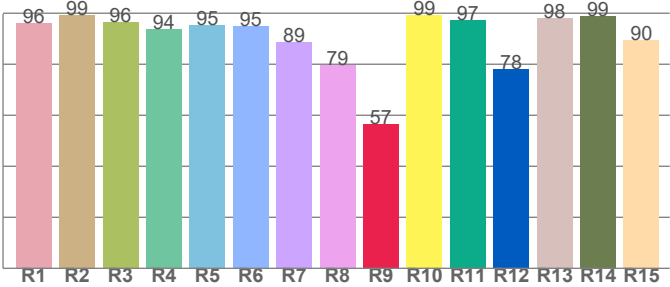

CRI R values, only R1-R8 are used to calculate final CRI value

| | | | | | | | | | | | | | | |
|------|------|------|------|------|------|------|------|------|------|------|------|------|------|------|
| R1 | R2 | R3 | R4 | R5 | R6 | R7 | R8 | R9 | R10 | R11 | R12 | R13 | R14 | R15 |
| 96.1 | 99.4 | 96.4 | 93.6 | 95.1 | 94.8 | 88.6 | 79.4 | 56.6 | 99.2 | 97.4 | 78.2 | 98.2 | 99.0 | 89.6 |

Spectral Power Distribution (SPD) / W/nm – 0-100%

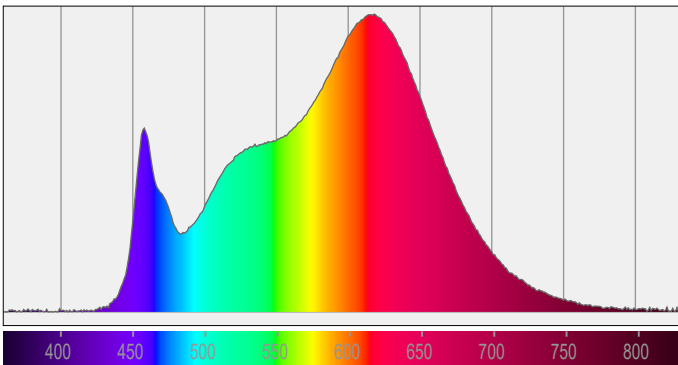

TM30-18 Rf-Values per Hue Bin

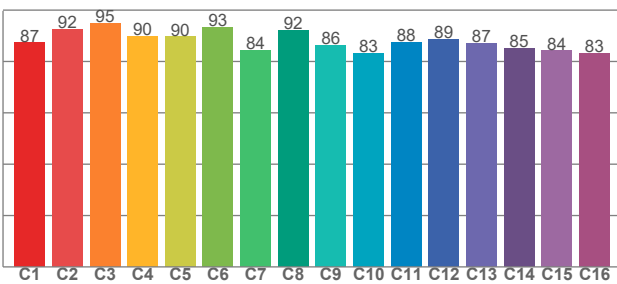

TM30 C values, 16 binned values out of total of 99 C values

| | | | | | | | | | | | | | | | |
|------|------|------|------|------|------|------|------|------|------|------|------|------|------|------|------|
| C1 | C2 | C3 | C4 | C5 | C6 | C7 | C8 | C9 | C10 | C11 | C12 | C13 | C14 | C15 | C16 |
| 87.3 | 92.4 | 95.0 | 89.9 | 89.6 | 93.2 | 84.5 | 92.1 | 86.4 | 83.3 | 87.6 | 88.7 | 87.2 | 85.1 | 84.1 | 83.2 |

Color Quality Scale by Reference Color

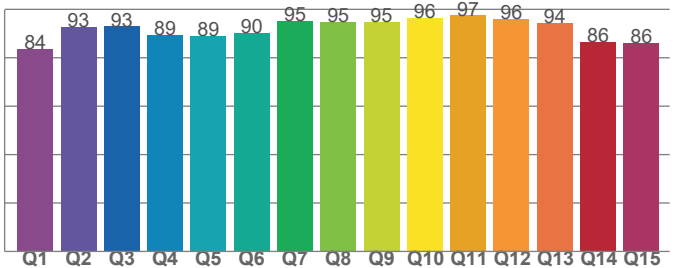

CQS Q values

| | | | | | | | | | | | | | | |
|------|------|------|------|------|------|------|------|------|------|------|------|------|------|------|
| Q1 | Q2 | Q3 | Q4 | Q5 | Q6 | Q7 | Q8 | Q9 | Q10 | Q11 | Q12 | Q13 | Q14 | Q15 |
| 83.8 | 92.6 | 92.9 | 89.5 | 88.9 | 90.4 | 95.1 | 94.8 | 94.9 | 96.3 | 97.4 | 95.9 | 94.2 | 86.5 | 86.0 |



Rf 88.4
Fidelity index Rf

Rg 95.4
Gamut index Rg

| Hue Bin | R _f | Shifts (%) | |
|---------|----------------|------------|------|
| | | Chroma | Hue |
| 1 | 87 | -5% | 3% |
| 2 | 92 | -3% | 2% |
| 3 | 95 | -2% | 1% |
| 4 | 90 | -5% | -4% |
| 5 | 90 | -9% | -1% |
| 6 | 93 | -4% | 1% |
| 7 | 84 | -8% | 6% |
| 8 | 92 | -1% | 5% |
| 9 | 86 | 0% | 10% |
| 10 | 83 | 2% | 10% |
| 11 | 88 | 6% | 8% |
| 12 | 89 | 6% | -4% |
| 13 | 87 | 0% | -10% |
| 14 | 85 | 1% | -12% |
| 15 | 84 | -5% | -5% |
| 16 | 83 | -4% | -11% |

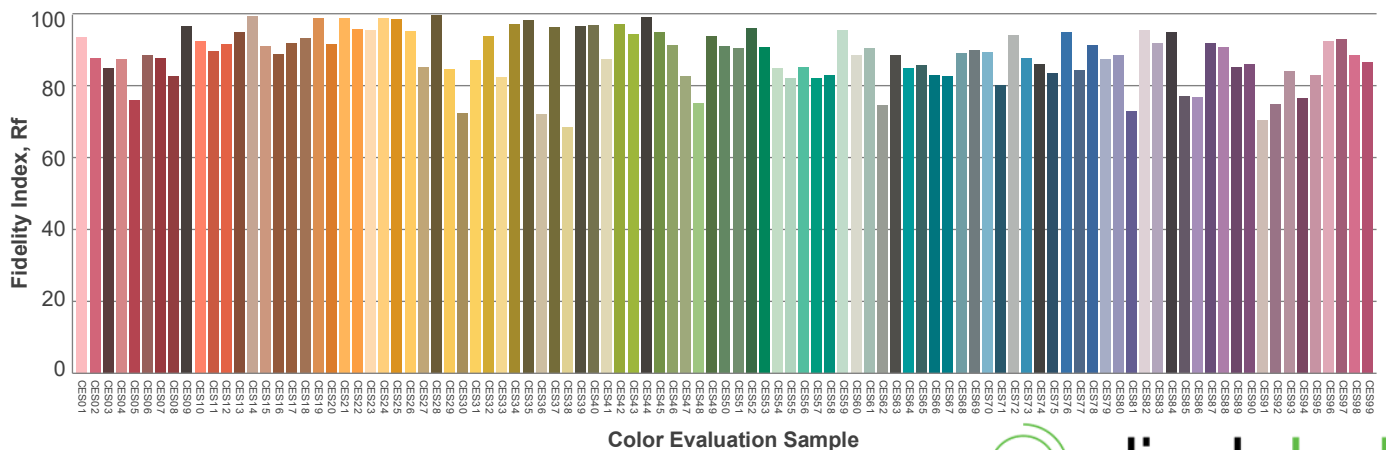
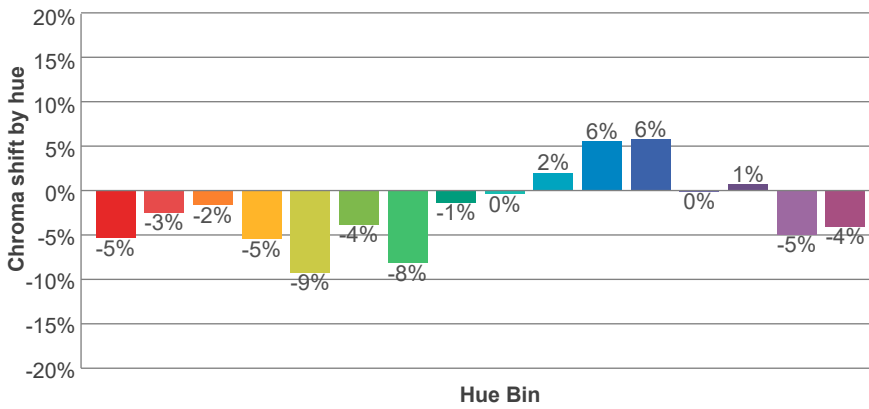
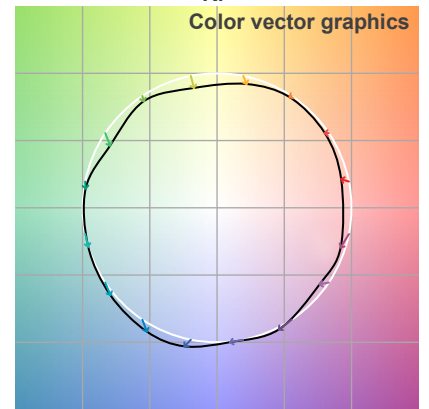
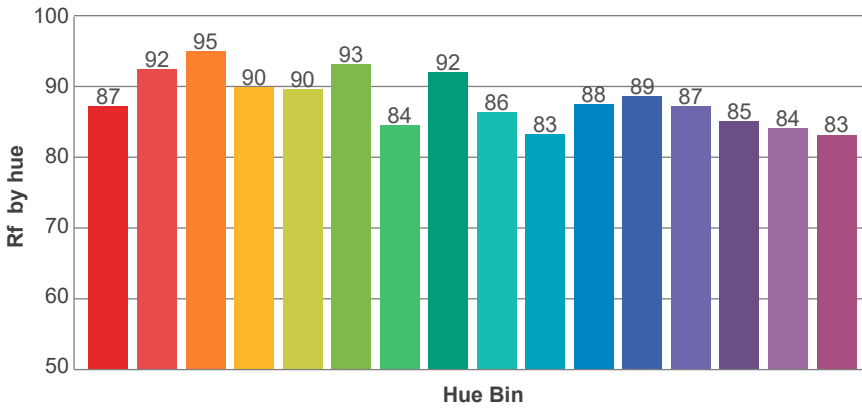
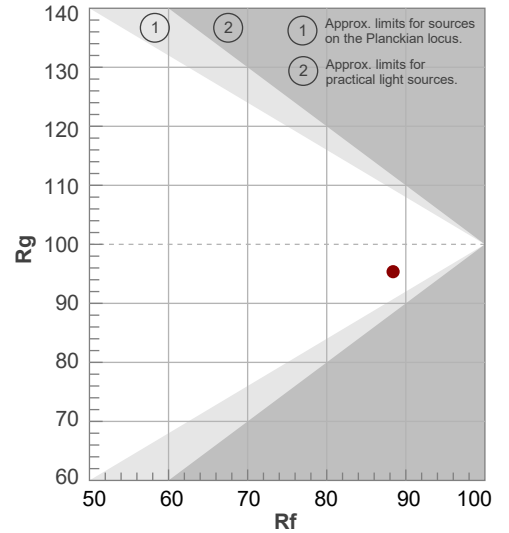

Beam Details

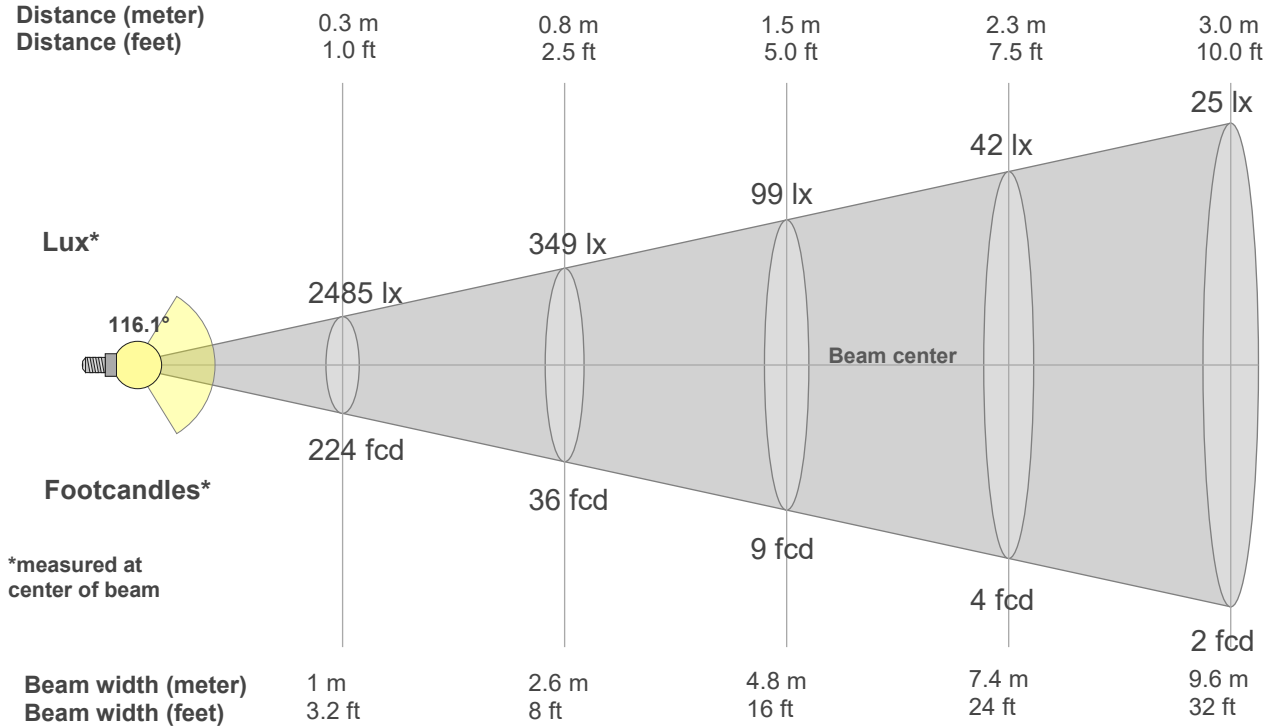

Beam Intensities from 1-20m

| | | | | | | | | | | | | | | | | | | | |
|---------|--------|--------|--------|--------|--------|--------|--------|--------|--------|--------|--------|--------|--------|--------|--------|--------|--------|--------|--------|
| 1m | 2m | 3m | 4m | 5m | 6m | 7m | 8m | 9m | 10m | 11m | 12m | 13m | 14m | 15m | 16m | 17m | 18m | 19m | 20m |
| 3.3ft | 6.6ft | 9.8ft | 13.1ft | 16.4ft | 19.7ft | 23ft | 26.2ft | 29.5ft | 32.8ft | 36.1ft | 39.4ft | 42.7ft | 45.9ft | 49.2ft | 52.5ft | 55.8ft | 59.1ft | 62.3ft | 65.6ft |
| 224lx | 56lx | 25lx | 14lx | 9lx | 6lx | 5lx | 3lx | 3lx | 2lx | 2lx | 2lx | 1lx | 1lx | 1lx | 1lx | 1lx | 1lx | 1lx | 1lx |
| 20.8fcd | 5.2fcd | 2.3fcd | 1.3fcd | 0.8fcd | 0.6fcd | 0.4fcd | 0.3fcd | 0.3fcd | 0.2fcd | 0.2fcd | 0.1fcd | 0.1fcd | 0.1fcd | 0.1fcd | 0.1fcd | 0.1fcd | 0.1fcd | 0.1fcd | 0.1fcd |

Intensities in 0° c-plane

| | | | | | | | | | | | | | | | | | | | |
|------|------|-----|-----|-----|-----|-----|-----|-----|-----|-----|-----|-----|-----|-----|-----|-----|-----|-----|-----|
| 0° | 5° | 10° | 15° | 20° | 25° | 30° | 35° | 40° | 45° | 50° | 55° | 60° | 65° | 70° | 75° | 80° | 85° | 90° | 95° |
| 224 | 223 | 220 | 216 | 210 | 202 | 193 | 181 | 169 | 155 | 139 | 123 | 105 | 86 | 66 | 47 | 28 | 12 | 2 | 0 |
| 100% | 100% | 98% | 97% | 94% | 90% | 86% | 81% | 76% | 69% | 62% | 55% | 47% | 38% | 30% | 21% | 13% | 6% | 1% | 0% |

Intensities in 90° c-plane

| | | | | | | | | | | | | | | | | | | | |
|------|-----|-----|-----|-----|-----|-----|-----|-----|-----|-----|-----|-----|-----|-----|-----|-----|-----|-----|-----|
| 0° | 5° | 10° | 15° | 20° | 25° | 30° | 35° | 40° | 45° | 50° | 55° | 60° | 65° | 70° | 75° | 80° | 85° | 90° | 95° |
| 224 | 222 | 220 | 216 | 210 | 202 | 193 | 183 | 170 | 157 | 141 | 125 | 106 | 87 | 67 | 47 | 27 | 12 | 1 | 0 |
| 100% | 99% | 98% | 97% | 94% | 91% | 86% | 82% | 76% | 70% | 63% | 56% | 48% | 39% | 30% | 21% | 12% | 5% | 1% | 0% |

Intensities in 180° c-plane

| | | | | | | | | | | | | | | | | | | | |
|------|------|-----|-----|-----|-----|-----|-----|-----|-----|-----|-----|-----|-----|-----|-----|-----|-----|-----|-----|
| 0° | 5° | 10° | 15° | 20° | 25° | 30° | 35° | 40° | 45° | 50° | 55° | 60° | 65° | 70° | 75° | 80° | 85° | 90° | 95° |
| 224 | 223 | 220 | 216 | 210 | 202 | 193 | 181 | 169 | 155 | 139 | 123 | 105 | 86 | 66 | 47 | 28 | 12 | 2 | 0 |
| 100% | 100% | 98% | 97% | 94% | 90% | 86% | 81% | 76% | 69% | 62% | 55% | 47% | 38% | 30% | 21% | 13% | 6% | 1% | 0% |

Intensities in 270° c-plane

| | | | | | | | | | | | | | | | | | | | |
|------|-----|-----|-----|-----|-----|-----|-----|-----|-----|-----|-----|-----|-----|-----|-----|-----|-----|-----|-----|
| 0° | 5° | 10° | 15° | 20° | 25° | 30° | 35° | 40° | 45° | 50° | 55° | 60° | 65° | 70° | 75° | 80° | 85° | 90° | 95° |
| 224 | 222 | 220 | 216 | 210 | 202 | 193 | 183 | 170 | 157 | 141 | 125 | 106 | 87 | 67 | 47 | 27 | 12 | 1 | 0 |
| 100% | 99% | 98% | 97% | 94% | 91% | 86% | 82% | 76% | 70% | 63% | 56% | 48% | 39% | 30% | 21% | 12% | 5% | 1% | 0% |

| | | | | |
|-----------------------|------------------------|--------------------------|-------------------------------------|------------------------------------|
| Beam angle 50% | Field angle 10% | Cutoff angle 2,5% | Intensity ratio in 120° cone | Intensity ratio in 90° cone |
| 116.7° | 163.3° | 176.8° | 77.1% | 51.8% |



Luminous Intensity Diagram

Unit: 0-100% of peak intensity

Main Values

| | |
|----------------------|----------------|
| Output (Total Lumen) | 675 lm |
| Lumen Up% / Down% | 0.66% / 99.34% |
| Peak Intensity | 224 cd |
| Beam Angle (50%) | 116.7° |
| Beam Angle (90%) | 117.3° |
| Beam Angle (10%) | 116.1° |

Cut-off Angle

| | |
|--------------|--------|
| Average 2,5% | 176.8° |
|--------------|--------|

Field Angle

| | |
|-------------|--------|
| Average 10% | 163.3° |
|-------------|--------|

Intensity Ratio

| | |
|--------------|-------|
| In 120° cone | 77.1% |
| In 90° cone | 51.8% |

C000-C180 C090-C270

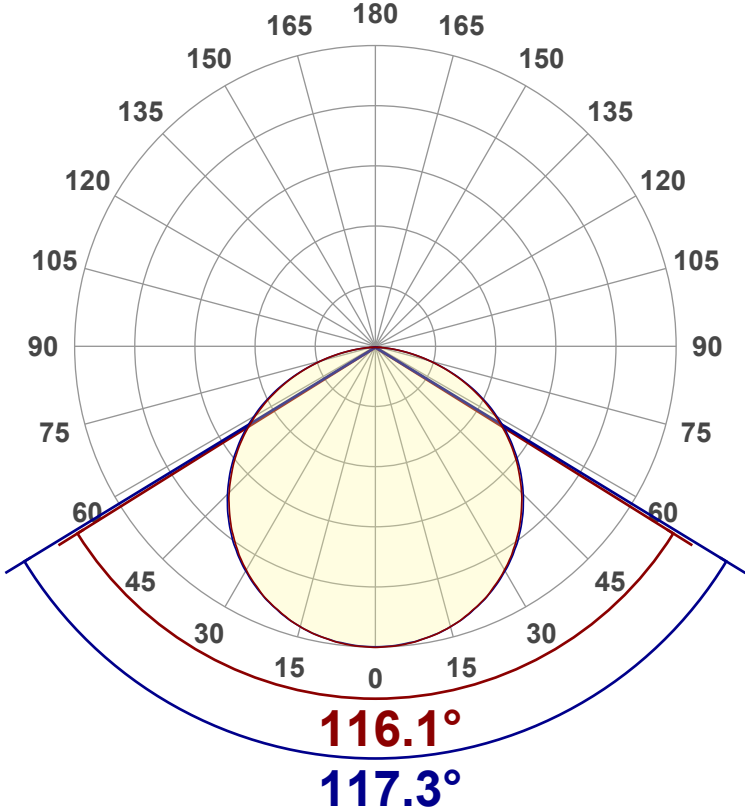

Zonal Lumen Summary

| | | | | | | | | |
|----------|-----------|-----------|-----------|-----------|-----------|-----------|-----------|-----------|
| 0°-10° | 10°-20° | 20°-30° | 30°-40° | 40°-50° | 50°-60° | 60°-70° | 70°-80° | 80°-90° |
| 21.2 lm | 61.0 lm | 93.4 lm | 114 lm | 120 lm | 111 lm | 85.8 lm | 49.6 lm | 14.7 lm |
| 90°-100° | 100°-110° | 110°-120° | 120°-130° | 130°-140° | 140°-150° | 150°-160° | 160°-170° | 170°-180° |
| 1.51 lm | 0.999 lm | 0.544 lm | 0.408 lm | 0.352 lm | 0.286 lm | 0.210 lm | 0.129 lm | 0.043 lm |



LCS Table

| BUG rating: | B0 U0 G0 | |
|----------------------|----------|----------|
| Forward light | Lumens | Lumens % |
| Low(0-30): | 88.4 | 13.1% |
| Medium(30-60): | 173.6 | 25.7% |
| High(60-80): | 68.1 | 10.1% |
| Very high(80-90): | 7.4 | 1.1% |
| Back light | | |
| Low(0-30): | 88.4 | 13.1% |
| Medium(30-60): | 173.6 | 25.7% |
| High(60-80): | 68.1 | 10.1% |
| Very high(80-90): | 7.4 | 1.1% |
| Uplight | | |
| Low(90-100): | 0 | 0% |
| High(100-180): | 0 | 0% |

LCS Graph

