



TUNABLE WHITE DMX WALL MOUNT ZONE CONTROLLER

INSTALLATION GUIDE

SAFETY & WARNINGS

1. Install in accordance with national and local electrical code regulations.
2. This product is intended to be installed and serviced by a qualified, licensed electrician.
3. DO NOT connect directly to high voltage power. Install with a compatible Class 2 constant voltage LED driver (power supply).
4. Only install compatible 12V and 24VDC constant voltage luminaires.
5. This product is rated for indoor installation and is not protected against moisture.
6. Do not modify product beyond instructions or warranty will be void.

QUICK SPECS / MODELS

DI-DMX-WIFI-WMUS-3Z-WH

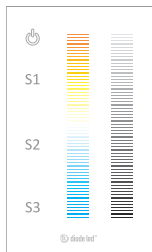

Input Voltage	12 - 24VDC Constant Voltage
Output Signal	DMX512
WiFi Transmitting Distance	40 ft.

TOOLS FOR INSTALL

Phillips-head screwdriver Flat-head screwdriver

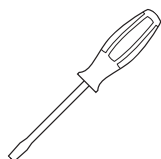
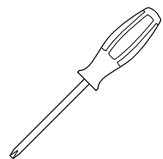

Mini flat-head screwdriver

Wire stripper

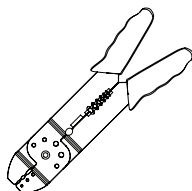

INSTALLATION

1 TURN POWER OFF AT CIRCUIT BREAKER



SHOCK HAZARD! May result in serious injury or death.
Turn power OFF at circuit breaker prior to installation.

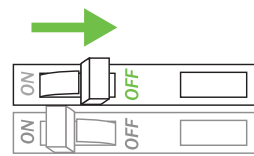

2 DETERMINE LOCATION TO INSTALL COMPONENTS

See **SYSTEM DIAGRAM** for more information. DMX luminaires can be connected directly to controller. DMX Decoders are only utilized to control Non-DMX type luminaires.

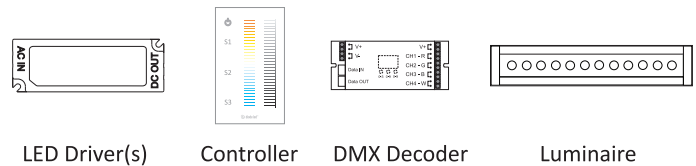

3 CONNECT COMPONENTS

Only use copper wiring. Reference **WIRING CONNECTIONS** and **SYSTEM DIAGRAM** further in this guide for visuals.

4 TURN POWER ON AT CIRCUIT BREAKER

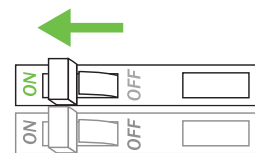

If system remains unresponsive or is working improperly, turn OFF main power at breaker and verify all connections.

INSTALLATION CONT.

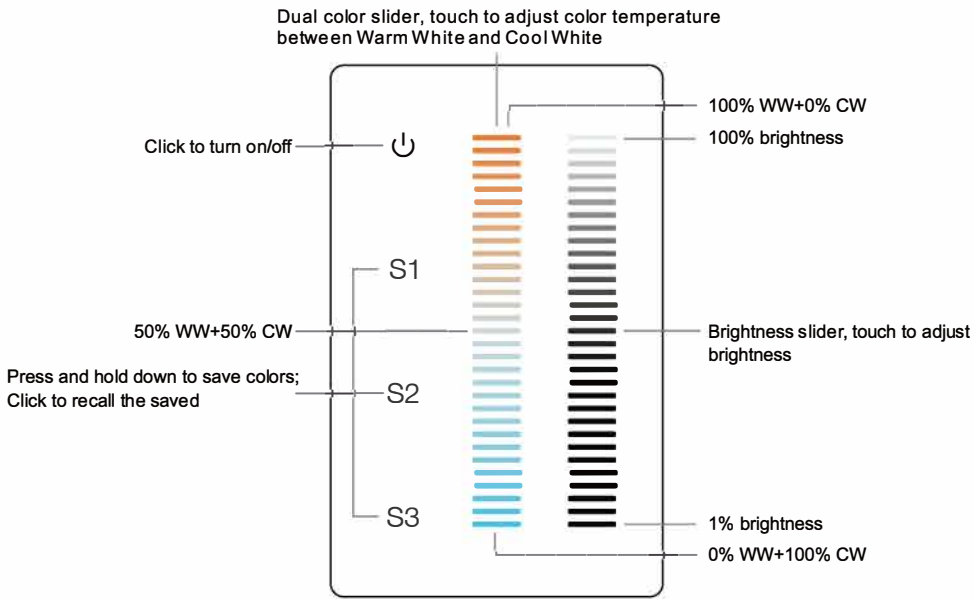

WIRING CONNECTIONS

*DO NOT connect directly to 120VAC.
See 'System Diagram' for a general system design.*

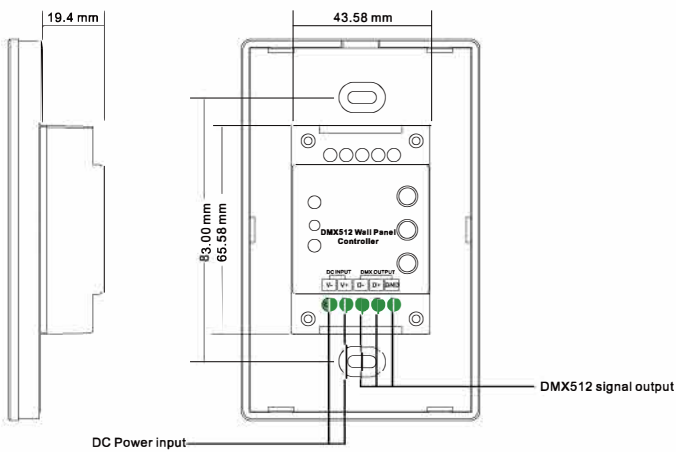

MOUNTING

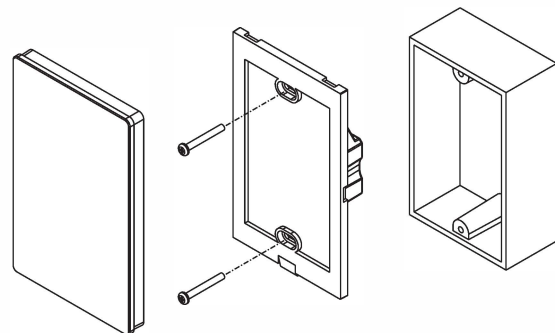
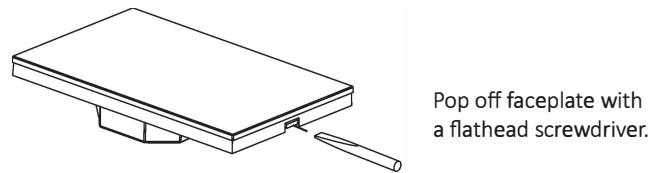

SETTING DMX ADDRESS

Each DMX decoder or DMX luminaire needs to be addressed correctly so the controller can distinguish between each decoder. To pair a DMX decoder or luminaire to a specific zone of the controller (1-3), set each decoder/luminaire to one of the following addresses:

- Zone 1: Set to address '001' (will be fixed to address 001 – 004)
- Zone 2: Set to address '005' (will be fixed to address 005 – 008)
- Zone 3: Set to address '009' (will be fixed to address 009 – 012)

Each zone of the controller is fixed with 4 DMX addresses to control the 4 channels:

CH1 – Red, CH2 – Green, CH3 – Blue, CH4 – White or X.

Once DMX address is set on luminaire or DMX decoder, ensure to Press Zone 1, 2, or 3 on the controller to control desired zone.

Example of DMX Addressing Display

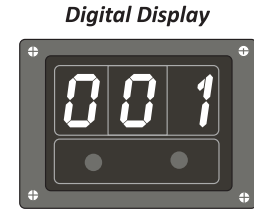

PINOUT CONNECTION GUIDE

The following diagrams/tables indicate the appropriate connections for patching your own CAT5/RJ45, and XLR-3 splice cables. These diagrams are for general reference and may slightly differ between different cable manufacturers.

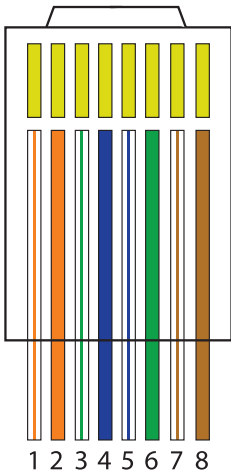

Pin No.	Wire Color	Function
1	White/Orange	Data +
2	Orange	Data -
3	White/Green	None
4	Blue	None
5	White/Blue	None
6	Green	None
7	White/Brown	May be used as 2nd ground
8	Brown	Ground

Pin No.	Function
1	Ground
2	Data -
3	Data +

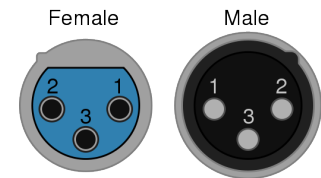

SYSTEM DIAGRAM

The following diagram is provided as an example system design. CAT5 (RJ45 connections) data cables are the most cost-effective solution for transmitting DMX-512 signals. XLR-3 cables may also be installed but require an additional adapter for connecting to DMX decoders. Always review each component installation guide for detailed and up-to-date wiring instructions. Install in accordance with NEC and local regulations.

Wiring diagram

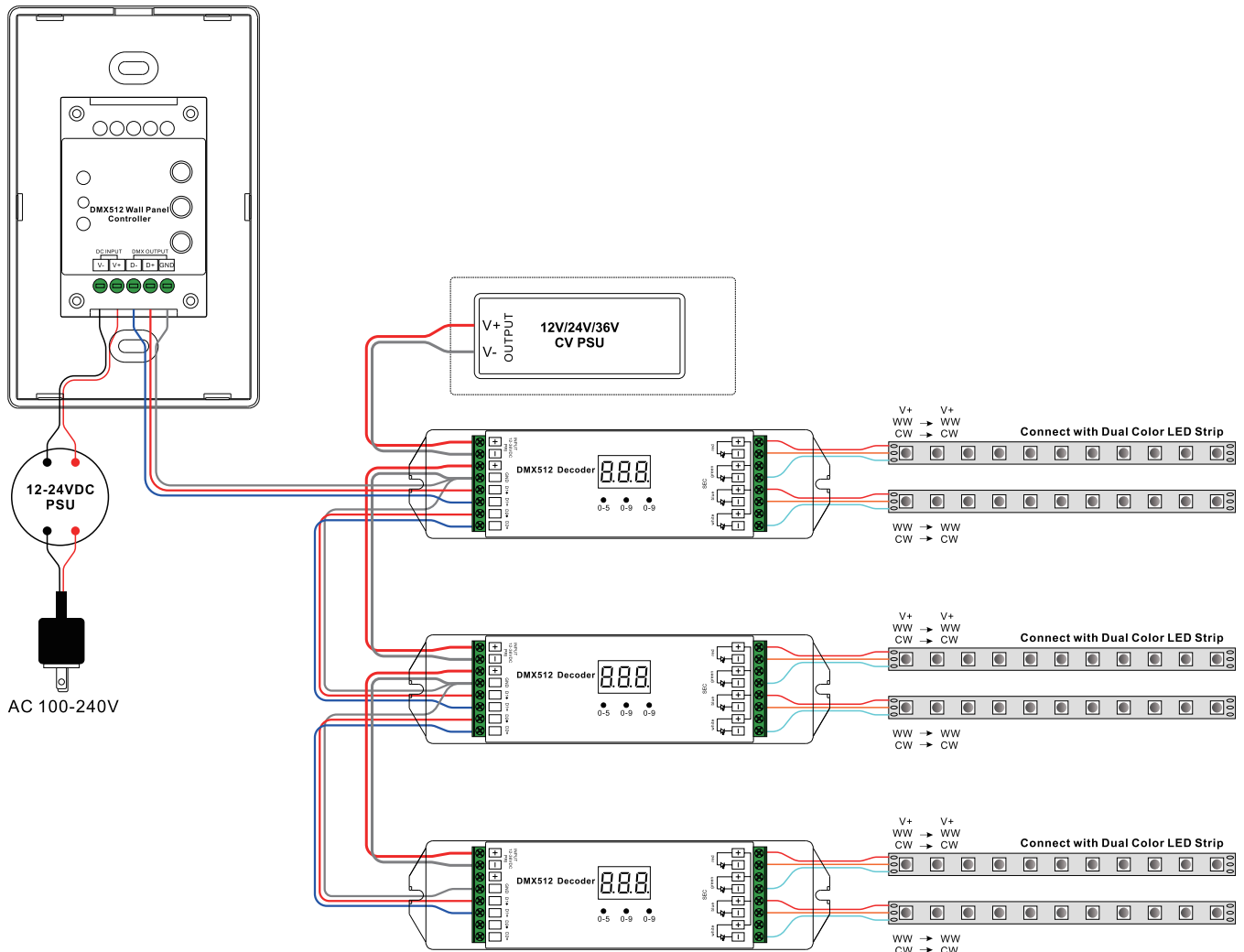

TROUBLESHOOTING

For thorough troubleshooting of LED strip light and luminaires, see LED luminaire installation guides.

LED luminaires not responding to touch

1. Ensure the blue indicator light is on by pressing 'Power.' A red indicator signifies the device is off. The blue indicator light will blink rapidly when pressing/holding any key on the touch pad.
2. Ensure the appropriate zone number was pressed prior to controlling the DMX decoder/luminaire. For example, if you know the luminaire is addressed to zone 1, press '1' prior to controlling.
3. Ensure the DMX decoder/luminaire is addressed properly. For example, address '001' will respond to zone 1 of the controller. See 'Setting the DMX Address' for additional addressing information.

LED luminaire responding incorrectly

Ensure all wiring connections are correct. Reversing the Data + and Data - will cause lights to flicker and not respond to controller.

1. Check power connections of all components (drivers, DMX decoders/luminaires, DMX controller).
2. Check DMX Data connections - See **Pinout Connection Guide** and **System Diagram** for RJ45 hard-wiring connections.
3. Check DMX decoder connections – See **System Diagram** for CH 1-4 connections.

ADDITIONAL RESOURCES

Visit the online product page at www.DiodeLED.com for additional product specifications & warranty information.

- **TUNABLE WHITE DMX512 CONTROLLER SPECIFICATION SHEET**

For full specifications.

- **VOLTAGE DROP CHARTS**

Use to specify appropriate wire gauge for installation. Available at the 'Resources' page at www.DiodeLED.com.



Toll Free: 877.817.6028 | Fax: 415.592.1596 | www.DiodeLED.com | info@DiodeLED.com
© 2019 Elemental LED Inc. All rights reserved. Specifications are subject to change without notice.