

TRIAN[®] 12V LED PUCK LIGHT

SPECIFICATION SHEET

- High brightness
- Surface and recess mounting
- Available in 3 finishes
- UL Listed
- 3-Year limited warranty

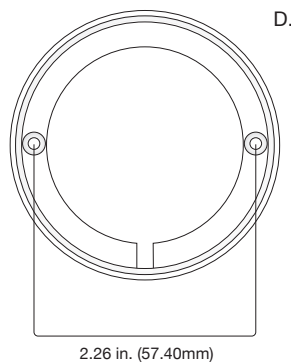
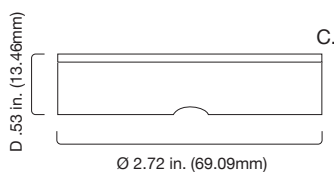
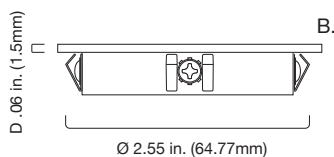
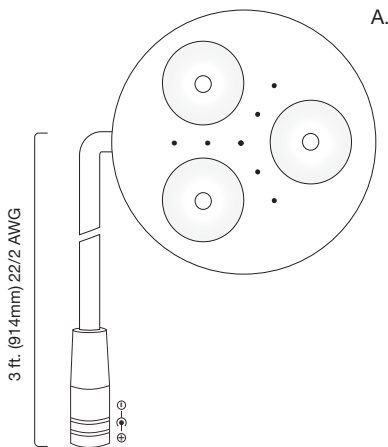

A. Top View
 B. Side Recessed View (No Mount Ring)
 C. Side View
 D. Surface Mount Ring

SPECIFICATIONS

Input Voltage: 12VDC Constant Voltage
Power Consumption / ft.: 3.92W / 326mA
LED Chip Type: 3 SAMSUNG 3535 SMD Chips
LED Chip Beam Angle: 120°
Mounting: Surface or recess mount (suitable for recess mount only inside cabinet/shelf)
Connections ¹: 36 in. female DC plug, Leads: 22/2 AWG

Ambient Temp ²: -4 ~ 122°F (-20 ~ 50°C)
Operating Temp ³: -4 ~ 176°F (-20 ~ 80°C)
Environment ⁴: Indoor / dry location
Dimensions: 2.72 x 0.53 in. (Dia x Depth), 2.5 in. (Recessed Dia)
Certifications: cULus Listed (US & Canada) #E351254 ANSI/UL 2108, CSA-C22.2 No. 9.0
Included Items: 1 surface mount ring, 2 mounting screws

Item #	CCT (Kelvin)	Lumens / ft. ⁵	CRI	Efficacy (lm/W) ⁶
DI-0332-SA (aluminum finish) DI-0332-SB (black satin finish) DI-0332-SW (white satin finish)	3000K	275	82	70.2
DI-0333-SA (aluminum finish) DI-0333-SB (black satin finish) DI-0333-SW (white satin finish)	6200K	348	74.5	88.8

- Note ¹** Attached connectors and connector accessories are not rated for in-wall installation unless otherwise noted. Attached connections are field cuttable.
- Note ²** Do not install product in an environment outside the listed ambient temperature. Exceeding the maximum ambient temperature may damage LED chips, reduce the total lamp life, lumen output, and/or adversely impact color consistency.
- Note ³** Operating temperature is measured according to the minimum and maximum ambient temperature environment.
- Note ⁴** Do not install in environment where LED chips are exposed to direct sunlight as damage to the phosphor will occur.
- Note ⁵** Lumen value measured in accordance to IES LM-79-08. LED chips have a luminous flux range with a tolerance of +/- 5%.
- Note ⁶** Actual efficacy value is dependent to specified LED driver (power supply). An estimated efficacy value has been provided and calculated as follows: Lumen value (measured in accordance to IES LM-79-08) divided by average power consumption per fixture.

Item #:	Project:
---------	----------

TRIAN® 3000K

DI-0332-XX

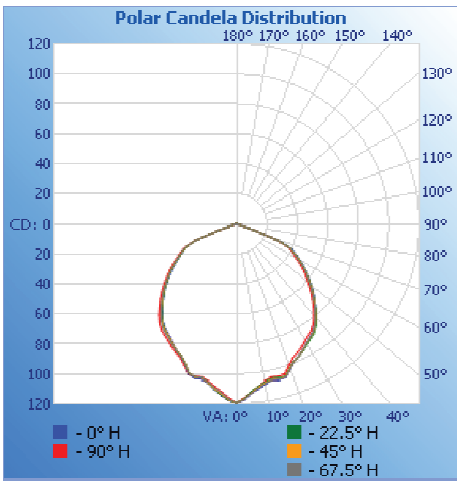

Intensity (Candlepower) Summary at 25°C - Candelas

Angle	0	22.5	45	67.5	90
0	119	119	119	119	119
5	113	112	113	113	112
10	108	107	108	108	106
15	108	106	107	107	105
20	103	102	102	103	100
25	97	97	97	97	95
30	92	92	92	92	90
35	88	89	88	88	86
40	81	82	81	81	79
45	72	72	72	72	70
50	64	64	64	63	62
55	56	56	55	55	53
60	47	47	47	46	45
65	40	40	39	38	38
70	12	12	12	12	12
75	0	0	0	0	0
80	0	0	0	0	0
85	0	0	0	0	0
90	0	0	0	0	0

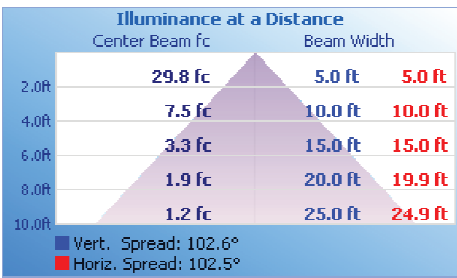

Zonal Lumen Summary and Percentages at 25°C

Zone	Lumens	% Luminaire
0-30	84.2	30.5
0-40	137.6	49.9
0-60	239.7	86.9
60-90	36.1	13.1
0-90	275.8	100.0
90-180	0.0	0.0
0-180	275.8	100.0

TRIAN® 6200K

DI-0333-XX

POLAR CANDELA DISTRIBUTION GRAPH

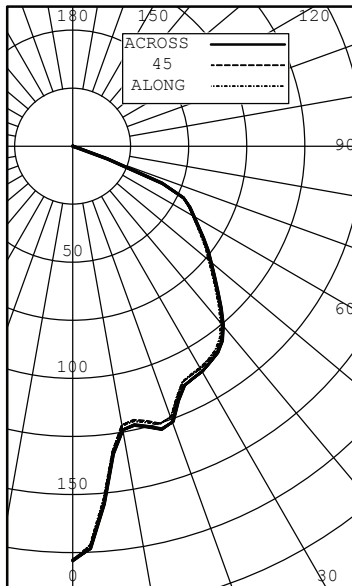

INTENSITY (CANDLEPOWER) SUMMARY

ANGLE	ALONG	22.5	45	67.5	ACROSS
0	178	178	178	178	178
5	152	154	154	154	155
10	123	124	122	123	124
15	123	125	123	124	125
20	124	125	124	125	126
25	112	113	112	113	114
30	110	112	111	111	112
35	107	109	108	108	109
40	99	101	100	100	101
45	87	89	88	88	88
50	77	78	78	77	78
55	68	69	68	68	69
60	60	61	60	59	60
65	53	54	53	52	53
70	15	16	15	15	16
75	0	0	0	0	0
80	0	0	0	0	0
85	0	0	0	0	0
90	0	0	0	0	0

ZONAL LUMENS AND PERCENTAGES

ZONE	LUMENS	% LUMINAIRE
0-30	102	29.31
0-40	169	48.61
0-60	298	85.81
0-90	348	100.00
40-90	179	51.39
60-90	49	14.19
90-180	0	0.00
0-180	348	100.00





Cone Of Light Tabulation

Mounting Height (Feet)	Footcandles at Nadir	Diameter (Feet)
4.00	11.1	3.48
6.00	4.94	5.22
8.00	2.78	6.96
10.0	1.78	8.71
12.0	1.23	10.4
14.0	0.907	12.2
16.0	0.695	13.9

* Photometric data complies with LM-79-08, ANSI C82.77-02.

ACCESSORIES

All fixture accessories including DC connections, etc. have a Class 2 amperage rating unless otherwise noted (60W/5A @ 12V DC; 100W/4.17A @ 24V DC).

Item #	Type	Description	Image
DI-0712F-**	Adapter Splice Cable - Female	Converts a male DC plug to a hard-wired connection. Wire: 22/2 AWG. Dimensions: 42 x 0.45 in. (L x W)	
DI-0712M-**	Adapter Splice Cable - Male	Converts a female DC plug to a hard-wired connection. Wire: 22/2 AWG. Dimensions: 42 x 0.45 in. (L x W)	
DI-0708-**	39 in. DC Extension Cable	Creates an extension between DC plugs. Wire: 20/2 AWG. Connector width: 0.45 in.	
DI-0720-** (2-way) DI-0705-** (3-way) DI-DCSP4-** (4-way) DI-0707-** (5-way)	DC Splitter	Splits a DC connection. Wire: 20/2 AWG. Dimensions: 8 x 0.6 x 0.3 in. (L x W x H)	

** Products available in 25x and 50x pack bulk quantities. Add -25 or -50 to each product # for bulk quantities.

SWITCHES, CONTROLS, LED DRIVERS, & SYSTEM DIAGRAMS

We offer a variety of switches, controls, and LED drivers (power supplies) to address all common light installations. For additional information, please see the additional component sections of our website or catalog. See the 'TRIANANT® 12V LED Puck Light Installation Guide' for system diagrams and installation instructions. For additional questions and concerns please contact technical support.

ADDITIONAL RESOURCES

Visit the on line product page at www.DiodeLED.com for additional resources including:

- **TRIAN® 12V LED PUCK LIGHT Installation Guide**
For system diagrams and full installation instructions.
- **Voltage Drop Charts**
Use to specify appropriate wire gauge for installation. Available at the 'Tools & Resources' page at www.DiodeLED.com.

SAFETY & DISCLOSURES

- Install in accordance with the National Electric Code and local regulations.
- This product is intended to be installed and serviced by a qualified, licensed electrician.
- This product requires a compatible LED driver for proper configuration. Do not connect directly to high voltage 120~277V AC power.
- The UL Listing of this product requires the fixture to be powered with a compatible Class 2 DC constant voltage LED driver (power supply).
- It is generally recommended to load the driver no more than 80% the labeled rating for maximum performance and longevity. However, see each driver specification sheet for exact minimum and maximum loading values.
- Do not install product in an environment outside the listed ambient temperature. Exceeding the maximum ambient temperature may damage LED chips, reduce the total lamp life, lumen output, and/or adversely impact color consistency.
- Operating temperature is measured according to the minimum and maximum ambient temperature environment.
- Do not install in environment where LED chips are exposed to direct sunlight as damage to the phosphor will occur.
- Ensure applicable wire is installed between driver, fixture, and any controls in-between. When choosing wire, factor in voltage drop, amperage rating, and type (in-wall rated, wet location rated, etc.). Inadequate wire installation could overheat wires, and cause fire.
- Attached wire leads or wire accessories are not rated for in-wall installation unless otherwise noted.
- 'Voltage drop' is a gradual decrease in voltage along a conductor through which current is flowing. When specifying an LED system, ensure to calculate voltage drop appropriately. Voltage drop calculators will suggest the proper gauge wire and distance to install the driver from the fixture. To meet maximum performance, the beginning of the tape light should be receiving no less than 3% of input power rating.
- All fixture accessories including CLICKTIGHT™ connectors, DC connections, etc. have a Class 2 amperage rating unless otherwise noted (60W/5A @ 12V DC; 100W/4.17A @ 24V DC).
- Do not modify or disassemble this product beyond instructions or the warranty will be void. Attached connections are field cuttable and will not void warranty if modified.
- Actual color may vary from what is pictured on this sheet and other print materials due to the limitations of photographic processes.
- Lighting technology has some amount of gradual light degradation (output and/or color) over the lifespan of the products. Diode LED products are designed to minimize degradation, but some light degradation and color shift is a normal part of the life span of any LED lighting system.
- We reserve the right to modify and improve the design of our fixtures without prior notice. We cannot guarantee to match existing installed fixtures for subsequent orders or replacements in regards to product appearance, CCT, or lumen output.

WARRANTY INFORMATION

Limited Warranty

This LED fixture has a three (3) year limited warranty from the date of shipment. This warranty does not include the additional accessories referenced in this specification sheet. Complete warranty details for fixtures and additional accessories are available at www.DiodeLED.com under the 'Tools & Resources' tab. For warranty related questions, please contact customer service.

Consumer's Acknowledgment

Diode LED stands behind its products when they are used properly and according to our specifications. By purchasing our products, the purchaser agrees and acknowledges that lighting design, configuration and installation is a complex process, wherein seemingly minor factors or changes in layout and infield adjustments can have a significant impact on an entire system. Choosing the right components is essential. Diode LED is able to work with the original purchaser to make an appropriate product selection to the extent of the limited information that the customer can provide, but it is virtually impossible for Diode LED to design a system that foresees every unknown factor. For this reason, this Warranty does not cover problems caused by improper design, configuration or installation issues. Any statement from a Diode LED employee or agent regarding a customer's bill of goods and/or purchase order is NOT an acknowledgment that the products purchased are designed and configured correctly. The purchaser agrees and acknowledges that it is the customer's responsibility to adhere strictly to all information contained in the Product Specification Sheets.

There is often more than one way to design, configure and layout an LED lighting application properly to achieve the same lighting effect. Diode LED strongly recommends that licensed professionals be used in the design and installation of lighting systems that include Diode LED products. The specifications include important information that a designer and installer should carefully review and strictly follow. Qualified designers and certified and/or licensed installers, with access to the final installation environment, customer goals, and Diode LED product specifications can make the requisite decisions appropriate for a successful finished lighting application.



Toll Free: 877.817.6028 | Fax: 415.592.1596 | www.DiodeLED.com | info@DiodeLED.com
© 2015 Elemental LED, Inc. All rights reserved. Specifications are subject to change without notice.