

SPOTMOD® 12V LED FIXTURE

SPECIFICATION SHEET

- Medium brightness
- Outdoor / wet location
- Surface mountable
- ETL Listed
- 5-Year limited warranty



TOP PROFILE

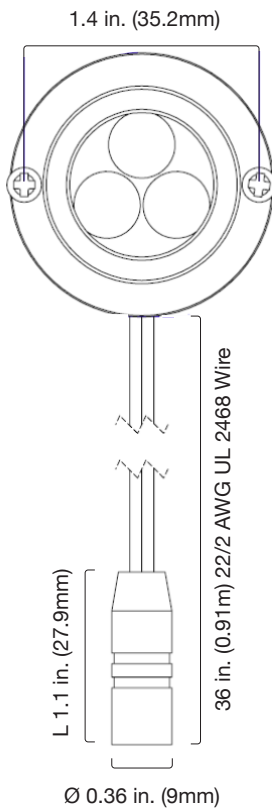

SPECIFICATIONS

Input Voltage: 12VDC Constant Voltage
Power Consumption: 2.13W / 176mA
LED Chip Type: 3 NICHIA 3030 LED Chips
LED Chip Beam Angle: 15° or 45°
Mounting¹: Suitable for surface mount only.
Connections²: 36 in. female wet location plug (9mm Dia.). 22/2 AWG UL 2468 wire
Dimmable: Yes
Ambient Temp³: -4 ~ 122°F (-20 ~ 50°C)

Operating Temp⁴: -4 ~ 176°F (-20 ~ 80°C)
Environment⁵: Outdoor / Wet location / IP65
Dimensions: 1.56 x 1.11 in. (Dia. x Depth)
Certifications: ETL Listed (US and Canada) 4001928. UL 2108 Low Voltage Luminaire, CSA C22.2 #250.0
Included Items: (2x) #4 x 0.6in. Phillips pan head mounting screws.

Item #	CCT (Kelvin)	Beam Angle	Lumens ⁶	CRI	Efficacy (lm/W) ⁷
DI-SPOT-SP30-45-BA	3000K	45°	130	82	61.03
DI-SPOT-SP30-15-BA	3000K	15°	134	82	62.91

Note¹ Not suitable for recessed mounting.

Note² Attached connectors and connector accessories are not rated for in-wall installation unless otherwise noted. Attached connections are field cuttable.

Note³ Do not install product in an environment outside the listed ambient temperature. Exceeding the maximum ambient temperature may damage LED chips, reduce the total lamp life, lumen output, and/or adversely impact color consistency.

Note⁴ Operating temperature is measured according to the minimum and maximum ambient temperature environment.

Note⁵ Do not install near or around chlorinated/treated water. This product is not rated as submersible. Suitable for installation in direct sunlight. Do not install in location where water may pool or collect.

Note⁶ Lumen value measured in accordance to IES LM-79-08. LED chips have a luminous flux range with a tolerance of +/- 5%.

Note⁷ Actual efficacy value is dependent to specified LED driver (power supply). An estimated efficacy value has been provided and calculated as follows: Lumen value (measured in accordance to IES LM-79-08) divided by average power consumption per fixture.

SIDE PROFILE

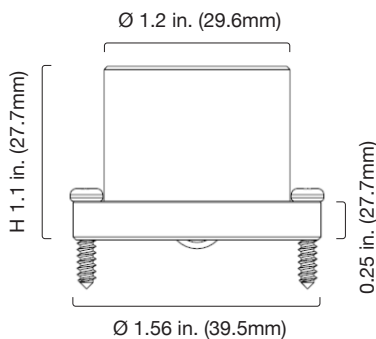

Item #:		Project:	
---------	--	----------	--

SPOTMOD® 45° 3000K
DI-SPOT-SP30-45-BA

POLAR CANDELA DISTRIBUTION GRAPH

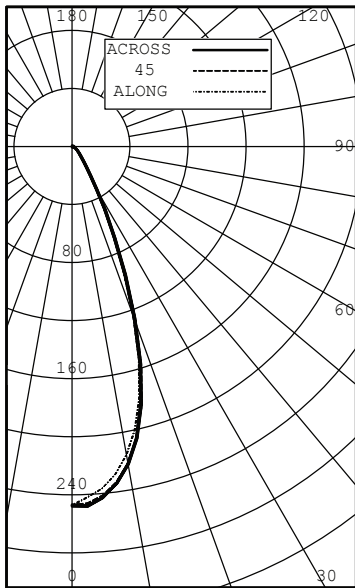

INTENSITY (CANDLEPOWER) SUMMARY

ANGLE	ALONG	22.5	45	67.5	ACROSS
0	247	247	247	247	247
5	237	239	241	243	243
10	216	219	222	223	222
15	179	182	185	185	184
20	123	124	128	127	126
25	66	68	70	69	70
30	32	33	33	34	34
35	16	17	17	18	18
40	10	10	11	11	11
45	7	7	7	7	7
50	6	5	6	6	5
55	4	4	4	4	4
60	3	3	3	3	3
65	3	3	3	3	3
70	2	2	2	2	2
75	1	1	1	1	1
80	1	1	1	1	1
85	0	0	0	0	0
90	0	0	0	0	0

ZONAL LUMENS AND PERCENTAGES

ZONE	LUMENS	% LUMINAIRE
0-30	104	80.16
0-40	115	89.03
0-60	125	96.49
0-90	130	100.00
40-90	14	10.97
60-90	5	3.51
90-180	0	0.00
0-180	130	100.00

Cone Of Light Tabulation

Mounting Height (Feet)	Footcandles at Nadir	Diameter (Feet)
4.00	15.5	2.66
6.00	6.88	3.99
8.00	3.87	5.32
10.0	2.48	6.65
12.0	1.72	7.98
14.0	1.26	9.31
16.0	0.968	10.6

SPOTMOD® 15° 3000K
DI-SPOT-SP30-15-BA

POLAR CANDELA DISTRIBUTION GRAPH

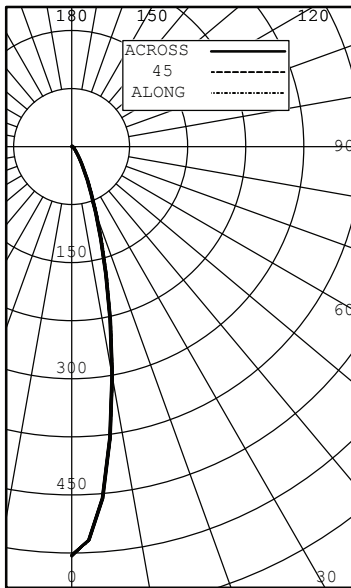

INTENSITY (CANDLEPOWER) SUMMARY

ANGLE	ALONG	22.5	45	67.5	ACROSS
0	528	528	528	528	528
5	456	456	457	458	456
10	305	304	304	304	300
15	176	175	174	173	171
20	98	96	96	94	91
25	53	51	51	50	48
30	28	28	28	27	26
35	16	16	16	15	15
40	10	10	10	10	9
45	7	7	7	7	6
50	5	5	5	5	5
55	4	4	4	4	4
60	3	3	3	3	3
65	2	2	2	2	2
70	2	2	2	2	2
75	1	1	1	1	1
80	1	1	1	1	1
85	0	0	0	0	0
90	0	0	0	0	0

ZONAL LUMENS AND PERCENTAGES

ZONE	LUMENS	% LUMINAIRE
0-30	111	82.98
0-40	122	90.56
0-60	130	97.03
0-90	134	100.00
40-90	13	9.44
60-90	4	2.97
90-180	0	0.00
0-180	134	100.00





Cone Of Light Tabulation

Mounting Height (Feet)	Footcandles at Nadir	Diameter (Feet)
4.00	32.9	1.54
6.00	14.6	2.30
8.00	8.22	3.07
10.0	5.26	3.84
12.0	3.65	4.61
14.0	2.68	5.38
16.0	2.05	6.14

* Photometric data complies with LM-79-08, ANSI C82.77-02.

ACCESSORIES

SPOTMOD® LED Fixtures feature 9mm wet location plugs. These plugs are compatible with the following 9mm accessories. All fixture accessories including Wet Location Connections, etc. have a Class 2 amperage rating unless otherwise noted (60W/5A @ 12V DC; 100W/4.17A @ 24V DC).

Item #	Type	Description	Image
DI-0710-M-** (<i>Male</i>) DI-0710-F-** (<i>Female</i>)	Wet Location Plug (9mm) to DC Connector	Attaches a wet location plug to a male DC accessory or plug-in adapter (not rated for wet location environments). Gender specification applies to the wet location connection only. Wire: 20/2 AWG. Dimensions: 7 x 0.3 in. (L x W)	
DI-0725-**	Wet Location Solder Connector Pair (9mm Plugs)	Converts a wet location plug to a hard-wired connection (1x male & 1x female wet location plug). Wire: 22/2 AWG. Dimensions: 4.5 x 0.3 in. (L x W)	
DI-0757-** (<i>6 in.</i>) DI-0758-** (<i>12 in.</i>) DI-0759-** (<i>24 in.</i>) DI-0709-** (<i>39 in.</i>) DI-0810-** (<i>16 ft.</i>)	Wet Location Extension Cable (9mm Plugs)	Creates an extension between wet location plugs. Wire: 22/2 AWG. Connector width: 0.3 in.	
DI-0804-** (<i>2-way</i>) DI-0805-** (<i>3-way</i>) DI-0806-** (<i>5-way</i>)	Wet Location Splitter Cable (9mm Plugs)	Splits a connection for wet location accessories. Wire: 22/2 AWG. Dimensions: 8.5 x 0.6 x 0.3 in. (L x W x H) Connector width: 0.3 in.	

** Products available in 25x and 50x pack bulk quantities. Add -25 or -50 to each product # for bulk quantities.

SWITCHES, CONTROLS, LED DRIVERS, & SYSTEM DIAGRAMS

We offer a variety of switches, controls, and LED drivers (power supplies) to address all common light installations. For additional information, please see the additional component sections of our website or catalog. See the 'SPOTMOD® 12V LED FIXTURE Installation Guide' for system diagrams and installation instructions. For additional questions and concerns please contact technical support.

ADDITIONAL RESOURCES

Visit the on line product page at www.DiodeLED.com for additional resources including:

- **SPOTMOD® 12V LED FIXTURE Installation Guide**
For system diagrams and full installation instructions.
- **Voltage Drop Charts**
Use to specify appropriate wire gauge for installation. Available at the 'Tools & Resources' page at www.DiodeLED.com.

SAFETY & DISCLOSURES

- Install in accordance with the national and local electrical code regulations.
- This product is intended to be installed and serviced by a qualified, licensed electrician.
- This product must be powered with a compatible Class 2 DC constant voltage LED driver (power supply).
- Do not connect directly to high voltage or AC power.
- Suitable for surface mounting only. This fixture is not suitable for recessed mounting.
- Do not install near or around chlorinated/treated water. This product is not rated as submersible. Suitable for installation in direct sunlight. Do not install in location where water may pool or collect.
- It is generally recommended to load the driver no more than 80% the labeled rating for maximum performance and longevity. However, see each driver specification sheet for exact minimum and maximum loading values.
- Do not install product in an environment outside the listed ambient temperature. Ensure adequate airflow and heatsinking is considered when mounting/installing.
- Operating temperature is measured according to the minimum and maximum ambient temperature environment. Exceeding the maximum operating temperature may damage the controller or fixture.
- Ensure applicable wire is installed between driver, fixture, and any controls in-between. When choosing wire, factor in voltage drop, amperage rating, and type (in-wall rated, wet location rated, etc.). Inadequate wire installation could overheat wires, and cause fire.
- 'Voltage drop' is a gradual decrease in voltage along a conductor through which current is flowing. When specifying an LED system, ensure to calculate voltage drop appropriately. Voltage drop calculators will suggest the proper gauge wire and distance to install the driver from the fixture.
- Attached wire leads, and additional extension cables, connectors, etc., are not rated for in-wall installation unless otherwise noted.
- All fixture accessories including wet location connectors, DC connections, etc. have a Class 2 amperage rating unless otherwise noted (60W/5A @ 12V DC; 100W/4.17A @ 24V DC).
- Do not modify or disassemble this product beyond instructions or the warranty will be void. Attached connections are field cuttable and will not void warranty if modified.
- Actual color may vary from what is pictured on this sheet and other print materials due to the limitations of photographic processes.
- We reserve the right to modify and improve the design of our fixtures without prior notice. We cannot guarantee to match existing installed fixtures for subsequent orders or replacements in regards to product appearance, CCT, or lumen output.

WARRANTY INFORMATION

Limited Warranty

This LED fixture has a five (5) year limited warranty from the date of shipment. This warranty does not include the additional accessories referenced in this specification sheet. Complete warranty details for fixtures and additional accessories are available at www.DiodeLED.com under the 'Tools & Resources' tab. For warranty related questions, please contact customer service.

Consumer's Acknowledgment

Diode LED stands behind its products when they are used properly and according to our specifications. By purchasing our products, the purchaser agrees and acknowledges that lighting design, configuration and installation is a complex process, wherein seemingly minor factors or changes in layout and in-field adjustments can have a significant impact on an entire system. Choosing the right components is essential. Diode LED is able to work with the original purchaser to make an appropriate product selection to the extent of the limited information that the customer can provide, but it is virtually impossible for Diode LED to design a system that foresees every unknown factor. For this reason, this Warranty does not cover problems caused by improper design, configuration or installation issues. Any statement from a Diode LED employee or agent regarding a customer's bill of goods and/or purchase order is NOT an acknowledgment that the products purchased are designed and configured correctly. The purchaser agrees and acknowledges that it is the customer's responsibility to adhere strictly to all information contained in the Product Specification Sheets.

There is often more than one way to design, configure and layout an LED lighting application properly to achieve the same lighting effect. Diode LED strongly recommends that licensed professionals be used in the design and installation of lighting systems that include Diode LED products. The specifications include important information that a designer and installer should carefully review and strictly follow. Qualified designers and certified and/or licensed installers, with access to the final installation environment, customer goals, and Diode LED product specifications can make the requisite decisions appropriate for a successful finished lighting application.



Toll Free: 877.817.6028 | Fax: 415.592.1596 | www.DiodeLED.com | info@DiodeLED.com
© 2020 Elemental LED, Inc. All rights reserved. Specifications are subject to change without notice.