

SAFETY & WARNINGS

1. Install in accordance with national and local electrical code regulations.
2. This product is intended to be installed and serviced by a qualified, licensed electrician.
3. Do not modify product beyond instructions or warranty will be void.
4. Do not submerge, nor install within 5 feet of a swimming pool.
5. Only install with a compatible Listed Class 2 DC LED driver.
6. Do not exceed maximum run recommended for Tape Light.
7. Failure to follow safety warnings, and installation instructions will void the warranty.

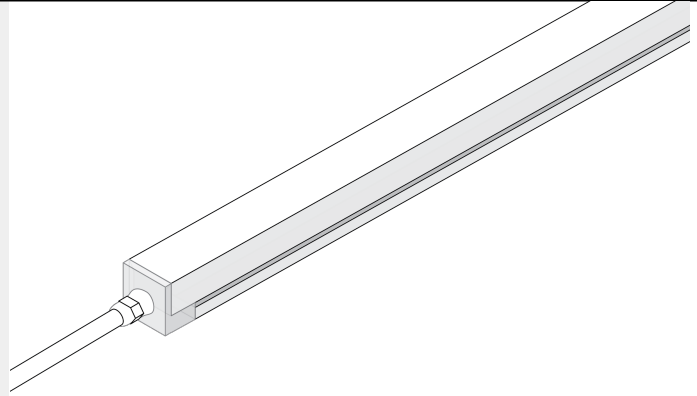

WARNING

DO NOT CONNECT DIRECTLY TO LINE VOLTAGE POWER!

Read all warnings and installation instructions thoroughly.

HANDLE WITH CARE

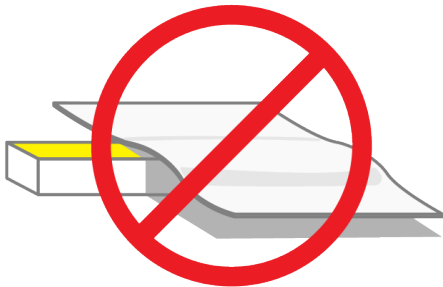

Do not cover with any materials.

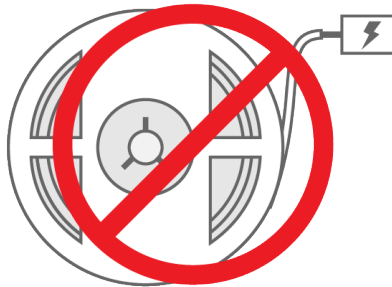

Do not power while attached to spool or tightly coiled.

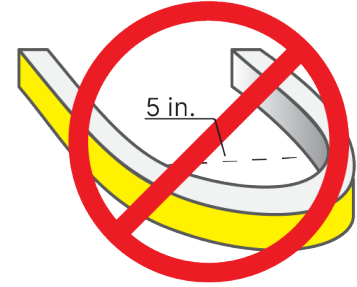

Do not bend to a diameter less than 5 inches.

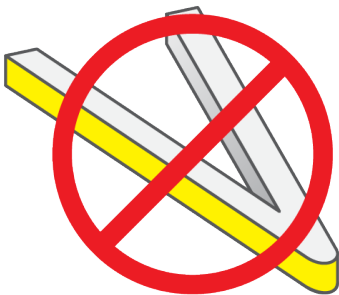

Do not fold, crease, or twist.

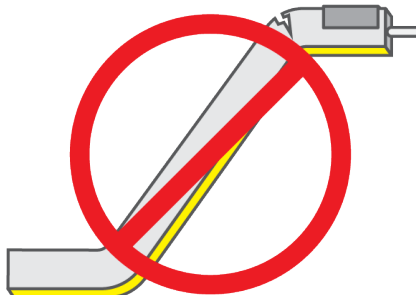

Do not allow product hang unsupported during installation.

0. Field Assembly

Assembling this product in the field has a maximum rating of IP65. We suggest the use of our Factory Assembly (IP67) program when installed in a wet location environment.

1. Turn Power Off at Circuit Breaker

Never cut product attached to a live circuit. Do not exceed Class 2 Limit.

2. Cut LINAIRE to length

LINAIRE may be cut anywhere along its length. Ensure a flat, straight cut.

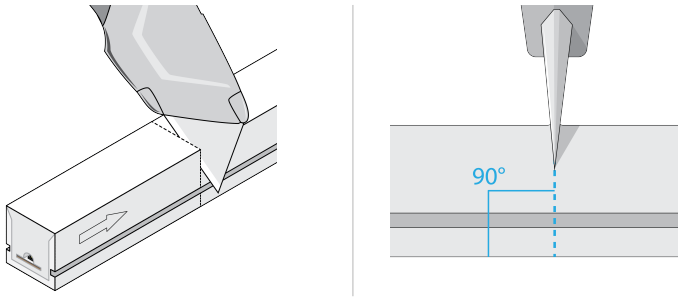

3. Attach End Cap

Apply Permatex® 80050 adhesive inside end cap then slide end cap over end of LINAIRE.

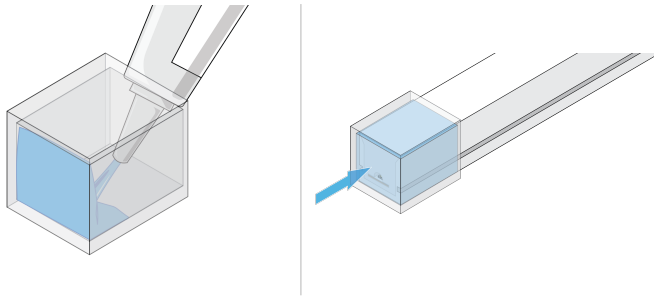

4A. Mounting (Channel)

Fasten channel to surface using mounting screws, then press LINAIRE into channel keeping connector flush with channel end. If factory assembled the entire luminaire will fit within channel.

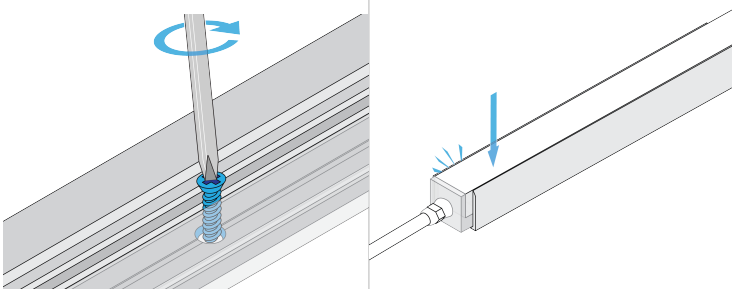

4B. Mounting (Bottom U-Clip)

At least every 6 inches, fasten bottom u-clips to surface using mounting screws, then press LINAIRE into bottom u-clip.

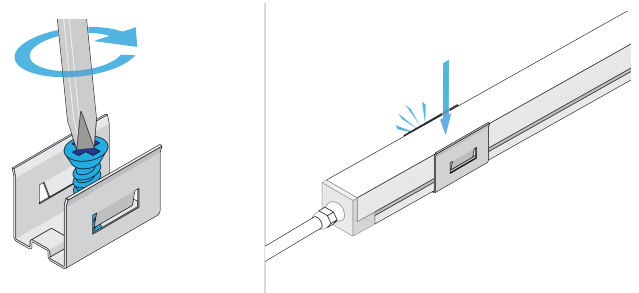

4C. Mounting (Spine Channel)

Fasten spine channel to surface using mounting screws, then press LINAIRE into channel keeping connector flush with spine channel end. If factory assembled the entire luminaire will fit within spine channel.

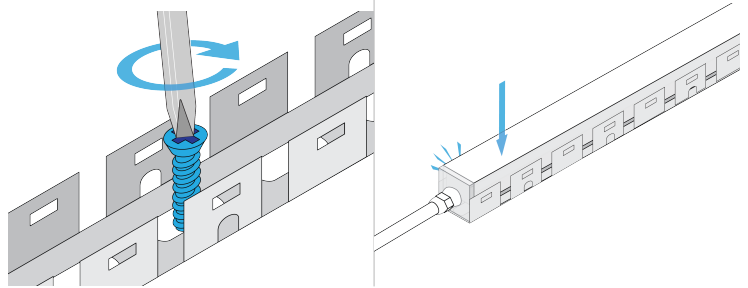

System Diagrams

Mount using included mounting clips/channels/screws.

The following diagram is an example system design. For information regarding larger systems or systems not pictured below, please see our web page or contact technical support. Always review each component installation guide for detailed and up-to-date wiring instructions. Install in accordance with national and local electrical codes.

Other diagrams will vary based on power and dimming requirements.

Standard Dimmer System Diagram

