



Item #	
Project	



DI-JBOX-LPS3R

COMPATIBLE DRIVERS
OMNIDRIVE [®]
OMNIDRIVE [®] Basics
Constant Voltage LED Drivers
24V DMX Driver Decoder
Commercial Grade 0-10V Dimmable Drivers
VLM Series Constant Voltage Drivers

OVERVIEW

The NEMA 3R Wet Location Junction Box is a great solution for outdoor installations. It is compatible with most of Diode LED's Driver line, and a robust way to protect your system.

FEATURES

- For use with a wide variety of Drivers.
- UL Listed
- 5-Year Warranty
- NEMA 3R Wet Location

SPECIFICATIONS

DI-JBOX-LPS3R	
Input Voltage	120-277VAC
Max Load	12V/60W, 24V/100W
Class 2 Certified	Yes
Ambient Temperature¹	-22 - 104°F (-30 - +40°C)
Operating Temperature²	-4 - 194°F (-20 - +90°C)
Environment	Outdoor / Wet Location
Working Humidity	5 - 95% RH non-condensing
Housing / Cooling	Nema3R
Dimensions	6.3 x 10.79 x 2.17 in. (L x W x D)
Warranty	5 Years
Certifications <i>DI-JBOX-LPS3R</i>	1. UL 508A (UL# E486215) Industrial Control Panel 2. UL 1598 (UL#E485321) Luminaire Fitting 3. UL2108 (UL#E469769 Class 2 power supply) Suitable for use in air handling spaces. Suitable for cabinet and surface mount use. Suitable for use in air handling spaces. Suitable for use in other environmental air spaces in accordance with section 300.22 (C) of the National Electrical Code.

COMPATIBLE DRIVERS

DI-TD-12V-10W-LPS3R	LO-PRO Small NEMA3R Wet Location Junction Box and Driver Combo - 12V OMNIDRIVE Electric Dimmable Driver - 10W
DI-TD-12V-20W-LPS3R	LO-PRO Small NEMA3R Wet Location Junction Box and Driver Combo - 12V OMNIDRIVE Electric Dimmable Driver - 20W
DI-TD-12V-30W-LPS3R	LO-PRO Small NEMA3R Wet Location Junction Box and Driver Combo - 12V OMNIDRIVE Electric Dimmable Driver - 30W
DI-TD-12V-45W-LPS3R	LO-PRO Small NEMA3R Wet Location Junction Box and Driver Combo - 12V OMNIDRIVE Electric Dimmable Driver - 45W
DI-TD-12V-60W-LPS3R	LO-PRO Small NEMA3R Wet Location Junction Box and Driver Combo - 12V OMNIDRIVE Electric Dimmable Driver - 60W
DI-TD-24V-10W-LPS3R	LO-PRO Small NEMA3R Wet Location Junction Box and Driver Combo - 24V OMNIDRIVE Electric Dimmable Driver - 10W
DI-TD-24V-20W-LPS3R	LO-PRO Small NEMA3R Wet Location Junction Box and Driver Combo - 24V OMNIDRIVE Electric Dimmable Driver - 20W
DI-TD-24V-30W-LPS3R	LO-PRO Small NEMA3R Wet Location Junction Box and Driver Combo - 24V OMNIDRIVE Electric Dimmable Driver - 30W
DI-TD-24V-45W-LPS3R	LO-PRO Small NEMA3R Wet Location Junction Box and Driver Combo - 24V OMNIDRIVE Electric Dimmable Driver - 45W
DI-TD-24V-60W-LPS3R	LO-PRO Small NEMA3R Wet Location Junction Box and Driver Combo - 24V OMNIDRIVE Electric Dimmable Driver - 60W
DI-TD-24V-80W-LPS3R	LO-PRO Small NEMA3R Wet Location Junction Box and Driver Combo - 24V OMNIDRIVE Electric Dimmable Driver - 80W
DI-TD-24V-96W-LPS3R	LO-PRO Small NEMA3R Wet Location Junction Box and Driver Combo - 24V OMNIDRIVE Electric Dimmable Driver - 96W
DI-CV-MW12V40W-277-LPS3R	LO-PRO Small NEMA3R Wet Location Junction Box and Driver Combo - 12V Commercial Grade Driver, Class 2 - 40W
DI-CV-MW12V60W-277-LPS3R	LO-PRO Small NEMA3R Wet Location Junction Box and Driver Combo - 12V Commercial Grade Driver, Class 2 - 60W
DI-CV-MW24V60W-277-LPS3R	LO-PRO Small NEMA3R Wet Location Junction Box and Driver Combo - 24V Commercial Grade Driver, Class 2 - 60W
DI-CV-MW24V90W-277-LPS3R	LO-PRO Small NEMA3R Wet Location Junction Box and Driver Combo - 24V Commercial Grade Driver, Class 2 - 90W
DI-DM-MW12V40W-0-10V-LPS3R	LO-PRO Small NEMA3R Wet Location Junction Box and Driver Combo - 12V Commercial Grade 0-10V Driver, Class 2 - 40W
DI-DM-MW12V60W-0-10V-LPS3R	LO-PRO Small NEMA3R Wet Location Junction Box and Driver Combo - 12V Commercial Grade 0-10V Driver, Class 2 - 60W
DI-DM-MW24V60W-0-10V-LPS3R	LO-PRO Small NEMA3R Wet Location Junction Box and Driver Combo - 24V Commercial Grade 0-10V Driver, Class 2 - 60W
DI-DM-MW24V90W-0-10V-LPS3R	LO-PRO Small NEMA3R Wet Location Junction Box and Driver Combo - 24V Commercial Grade 0-10V Driver, Class 2 - 90W
DI-DM-12V60W-0-10V-LPS3R	LO-PRO Small NEMA3R Wet Location Junction Box and Driver Combo - 12V 0-10V Dimmable Driver - 60W
DI-DM-24V100W-0-10V-LPS3R	LO-PRO Small NEMA3R Wet Location Junction Box and Driver Combo - 24V 0-10V Dimmable Driver - 100W
DI-0904-LPS3R	LO-PRO Small NEMA3R Wet Location Junction Box and Driver Combo - 12V Constant Voltage Driver, Class 2 - 20W
DI-0918-LPS3R	LO-PRO Small NEMA3R Wet Location Junction Box and Driver Combo - 12V Constant Voltage Driver, Class 2 - 35W
DI-0906-LPS3R	LO-PRO Small NEMA3R Wet Location Junction Box and Driver Combo - 12V Constant Voltage Driver, Class 2 - 60W
DI-DV-12V60W-277-LPS3R	LO-PRO Small NEMA3R Wet Location Junction Box and Driver Combo - 12V Constant Voltage Driver, Class 2, 120-277VAC - 60W
DI-0970-LPS3R	LO-PRO Small NEMA3R Wet Location Junction Box and Driver Combo - 24V Constant Voltage Driver, Class 2 - 35W
DI-DV-24V60W-277-LPS3R	LO-PRO Small NEMA3R Wet Location Junction Box and Driver Combo - 24V Constant Voltage Driver, Class 2, 120-277VAC - 60W
DI-0954-LPS3R	LO-PRO Small NEMA3R Wet Location Junction Box and Driver Combo - 24V Constant Voltage Driver, Class 2 - 96W
VLM60W-12-LPS3R	LO-PRO Small NEMA3R Wet Location Junction Box and Driver Combo - 12V VLM Constant Voltage Driver - 60W
VLM60W-24-LPS3R	LO-PRO Small NEMA3R Wet Location Junction Box and Driver Combo - 24V VLM Constant Voltage Driver - 60W
VLM100W-24-LPS3R	LO-PRO Small NEMA3R Wet Location Junction Box and Driver Combo - 24V VLM Constant Voltage Driver - 100W
VLM60W-48-LPS3R	LO-PRO Small NEMA3R Wet Location Junction Box and Driver Combo - 48V VLM Constant Voltage Driver - 60W
VLM100W-48-LPS3R	LO-PRO Small NEMA3R Wet Location Junction Box and Driver Combo - 48V VLM Constant Voltage Driver - 100W
DI-DMX-DCO-24V96W-277-LPS3R	LO-PRO Small NEMA3R Wet Location Junction Box and Driver Combo - 24V DMX Driver Decoder - 96W

MEASUREMENTS

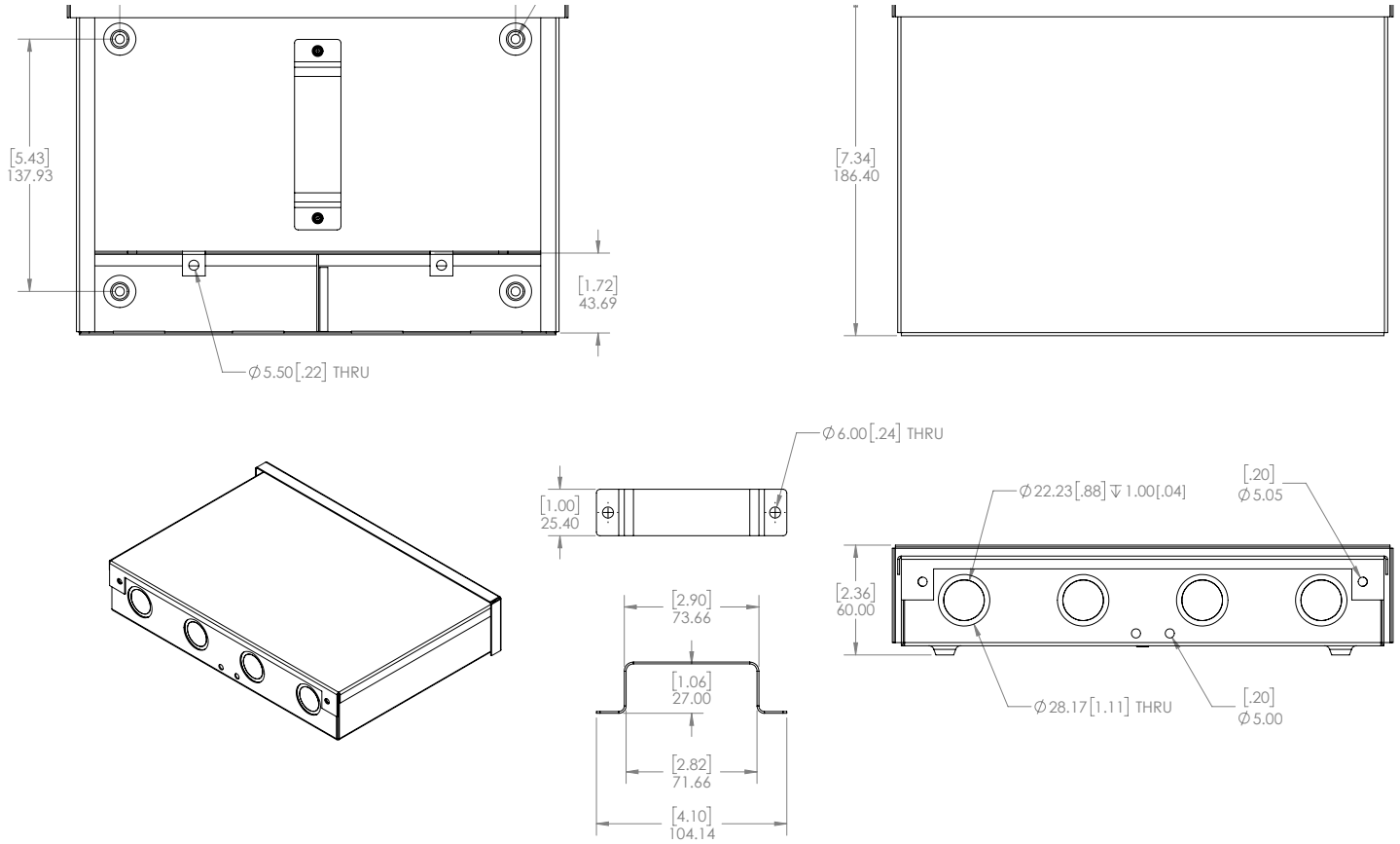

ADDITIONAL RESOURCES

NEMA3R Lo-Pro Junction Box INSTALLATION GUIDE

SAFETY / WARNINGS / DISCLOSURES

1. Install in accordance with national and local electrical code regulations.
2. This product is intended to be installed and serviced by a qualified, licensed electrician.
3. DO NOT modify product beyond instructions or warranty will be void.
4. Turn power OFF at main breaker before servicing or installing this product.
5. Proper heat dissipation will prolong the working lifespan of this product. Install in a well-ventilated area free from explosive gases and vapors.
6. Refer to the 'Static Characteristics Curve' if installing under low input voltage conditions to properly derate the power supply load
7. Refer to the 'Derating Curve' if nearing max. ambient temperature to properly derate the power supply load. Do not install product in an environment outside the listed ambient temperature.
8. Ensure a compatible LED fixture with the correct operating voltage is installed with this product.
9. To compensate for voltage drop, ensure applicable gauge in-wall rated wire is installed between driver and LED fixture.

WARRANTY

Limited Warranty

The five (5) year limited warranty of this product begins from the date of shipment. The warranty of each item can be found in the 'Specifications' chart under 'Warranty'. This warranty does not include the additional accessories referenced in this specification sheet. Complete warranty details for fixtures and additional accessories are available at www.diodeled.com/limited-warranty/ within the Policies section. For warranty related questions please contact product support.

Consumer's Acknowledgment

Diode LED stands behind its products when they are used properly and according to our specifications. By purchasing our products, the purchaser agrees and acknowledges that lighting design, configuration and installation is a complex process, wherein seemingly minor factors or changes in layout and infield adjustments can have a significant impact on an entire system. Choosing the correct components is essential. Diode LED is able to work with the original purchaser to make an appropriate product selection to the extent of the limited information that the customer can provide, but it is virtually impossible for Diode LED to design a system that foresees every unknown factor. For this reason, this Warranty does not cover problems caused by improper design, configuration or installation issues. Any statement from a Diode LED employee or agent regarding a customer's bill of goods and/or purchase order is NOT an acknowledgment that the products purchased are designed and configured correctly. The purchaser agrees and acknowledges that it is the customer's responsibility to adhere strictly to all information contained in the Product Specification Sheets.

There is often more than one way to design, configure and layout an LED lighting application properly to achieve the same lighting effect. Diode LED strongly recommends that licensed professionals be used in the design and installation of lighting systems that include Diode LED products. The specifications include important information that a designer and installer should carefully review and strictly follow. Qualified designers and certified and/or licensed installers, with access to the final installation environment, customer goals, and Diode LED product specifications can make the requisite decisions appropriate for a successful finished lighting application.

1. Do not install product in an environment outside the listed ambient temperature. Exceeding the maximum ambient temperature may result in damage.
2. Operating temperature is measured according to the minimum and maximum ambient temperature environment. Operating temperature is measured according to the minimum and maximum ambient temperature environment.



© 2020 Elemental LED, Inc. All rights reserved.
Specifications are subject to change without notice.

Toll Free: 877.817.6028 | Fax: 415.592.1596 | www.DiodeLED.com | info@DiodeLED.com

SPEC SHEET | NEMA3R LO-PRO® Junction Box | SS082820-1.0 | 4 OF 4