

BUNDLE CHANNELS

SPECIFICATION SHEET

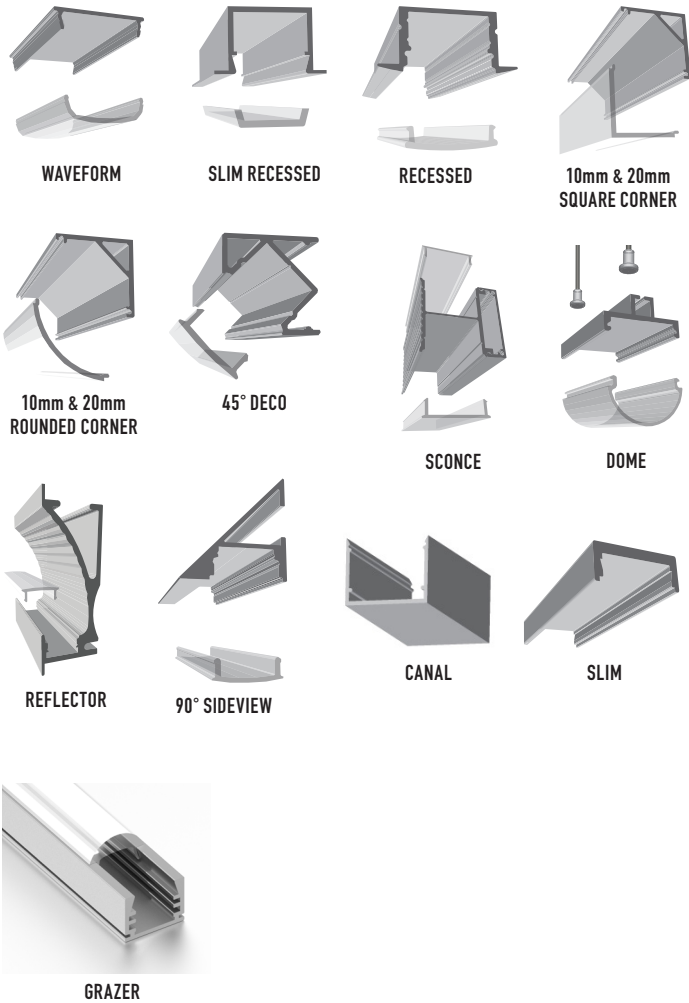

**OVERVIEW**

Bundle Channels are ready for loading tape light in the field. These channels protect indoor LED tape light by providing a rigid, dust proof housing that can be mounted on virtually any flat surface. These channels are sold in 48 inch bundles and help create sleek, completely customized LED tape lighting installations.

*Bundle Channels are not available in the Custom Fully Loaded Channel program. For Fully Loaded options see the 'Builder Channels' Specification Sheet.*

**FEATURES & BENEFITS**

- Industrial extrusions for custom lighting
- Bundles include: channel, lens, mounting clips, and end caps (mounting clips for surface & suspended mount channels only)
- Channels act as a heat sink, cooling and prolonging the LED tape light lifespan
- Provides additional defense from dust and debris, protecting the LED investment
- 5-Year Warranty

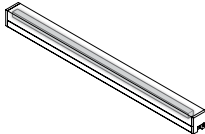

**PREMIUM DIFFUSED OPTIONS**  
Channels listed below eliminate LED hotspots by creating totally diffused linear light when paired with compatible tape light. See pg. 7 for compatible tape lights.

**20mm SQUARE CORNER**  
**20mm ROUNDED CORNER**  
**SCONCE**

**FINISHES**



Aluminum

Item #	
Project	

## SPECIFICATIONS

- Material: Aluminum
- Finish: Clear anodized aluminum
- Mounting Clip Material: Steel
- End Cap Material: PVC
- Cover Material: Polycarbonate
- Field Cuttable: Yes
- Mounting: Clips included. Additional clips available
- Dimensions: See Mechanical Diagrams
- Warranty: 5 years

## Environmental Requirements

- Suitable for indoor dry/damp location use

## Compliance & Regulatory Approvals

- Meets the following certifications when installed with compatible UL Listed tape light:
  - UL Listed 2108. UL 1598 / CSA 250.0-08, UL 8750. UL 879 / CAN/ CSA-C22.2 no. 207-M89. E469769 (UL Listed), E469770 (SAME Manual). 12V models are suitable for installation in a clothes closet.

## CHANNEL BUNDLES

**NOTE:** Channel Bundles are **not** interchangeable with each other **nor** compatible with **Builder** channels.

### CANAL CHANNEL

#### TAPE LIGHT COMPATIBILITY:

- |            |                  |
|------------|------------------|
| BLAZE™     | *DAZZLE® RGB     |
| BLAZE™ X   | *DAZZLE® RGBW    |
| *VALENT® X | *DAZZLE® RGBW 4D |

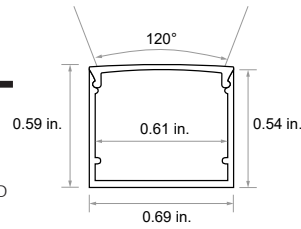

\*Soldered lead only

SKU	OPTION	INCLUDES
DI-CPCHB-CAN-48	48 in. Bundle	<ul style="list-style-type: none"> <li>• 48 in. channel &amp; opal lens</li> <li>• 2x surface mounting clips</li> <li>• End caps: 1x open, 1x closed.</li> </ul>
DI-CPCHB-CAN-96	96 in. Bundle	<ul style="list-style-type: none"> <li>• 96 in. channel &amp; opal lens</li> <li>• 4x surface mounting clips</li> <li>• End caps: 2x open, 2x closed.</li> </ul>
DI-CPCHB-CAN-ACC	Additional End Cap Bundles	<ul style="list-style-type: none"> <li>• 2x open, 2x closed End Caps</li> <li>• 4x surface mounting clips</li> </ul>

Also Available in Black and White Finishes! Use Suffix (B) for Black and (W) for White!

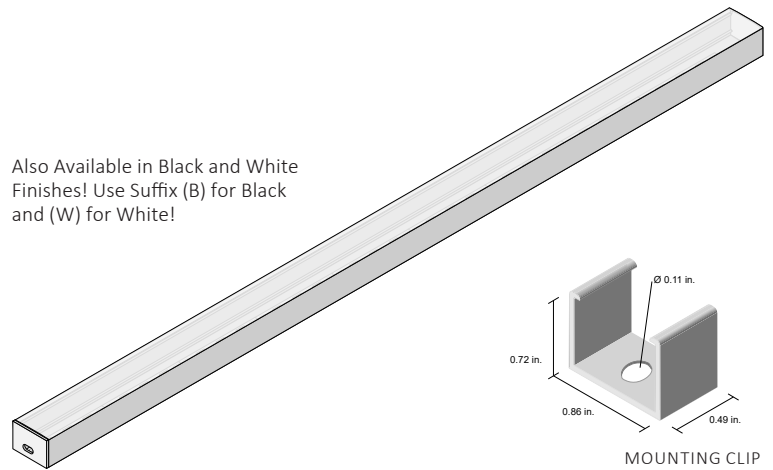

MOUNTING CLIP

### SLIM CHANNEL

#### TAPE LIGHT COMPATIBILITY:

- |           |                 |
|-----------|-----------------|
| BLAZE™    | DAZZLE® RGB     |
| BLAZE™ X  | DAZZLE® RGBW    |
| VALENT® X | DAZZLE® RGBW 4D |

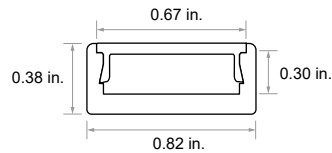

SKU	OPTION	INCLUDES
DI-CPCHB-SL-48	48 in. Bundle	<ul style="list-style-type: none"> <li>• 48 in. channel &amp; frosted cover</li> <li>• 2x mounting clips with screws</li> <li>• End caps: 1x open, 1x closed.</li> </ul>
DI-CPCHB-SL-96	96 in. Bundle	<ul style="list-style-type: none"> <li>• 96 in. channel &amp; frosted cover</li> <li>• 4x mounting clips with screws</li> <li>• End caps: 2x open, 2x closed.</li> </ul>

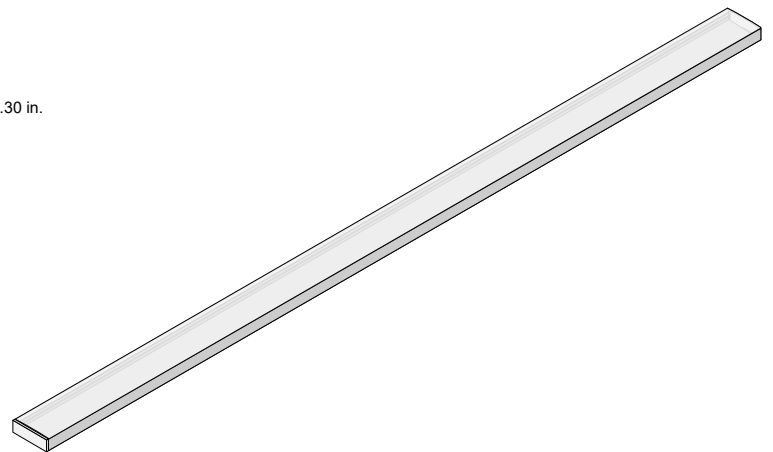

## CHANNEL BUNDLE CONT.

**NOTE:** Channel Bundles are **not** interchangeable with each other **nor** compatible with **Builder** channels.

# NARROW BEAM GRAZER CHANNEL

### TAPE LIGHT COMPATIBILITY:

BLAZE™  
BLAZE™ X  
BLAZE™  
COLORS

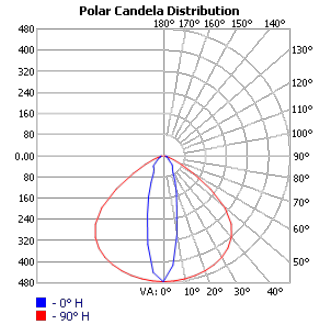
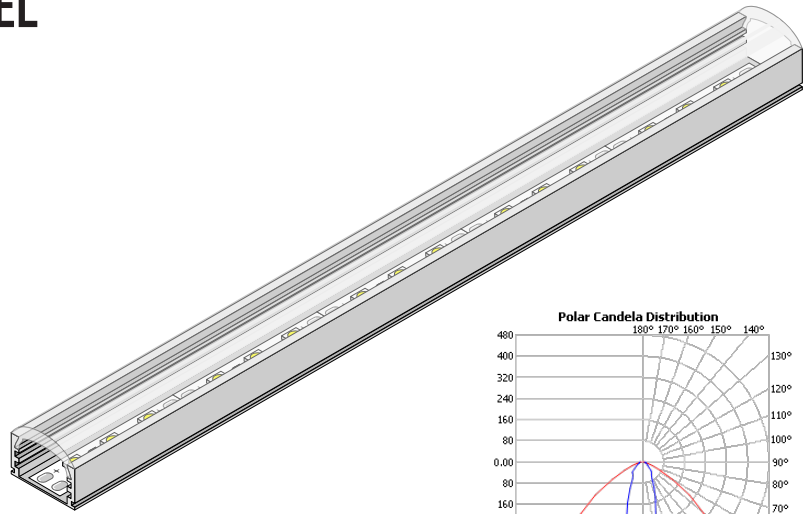
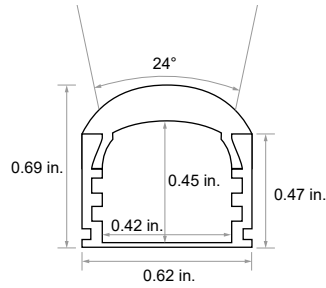

SKU	OPTION	INCLUDES
DI-CPCHB-GZRN-48	48 in. Bundle	<ul style="list-style-type: none"> <li>48 in. channel &amp; clear lens</li> <li>End caps: 1x open, 1x closed</li> <li>2x mounting clips</li> </ul>
DI-CPCHB-GZRN-96	96 in. Bundle	<ul style="list-style-type: none"> <li>96 in. channel &amp; clear lens</li> <li>End caps: 2x open, 2x closed</li> <li>4x mounting clips</li> </ul>
DI-CPCHB-GZRN-ACC	Additional End Cap Bundles	<ul style="list-style-type: none"> <li>2x open end caps, 2x closed end caps, 4x mounting clips</li> </ul>

## CHANNEL BUNDLE RECESSED

### TAPE LIGHT COMPATIBILITY:

BLAZE™ \*DAZZLE® RGB  
BLAZE™ X \*DAZZLE® RGBW  
\*VALENT® X \*DAZZLE® RGBW 4D

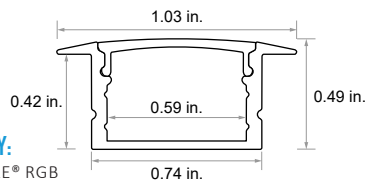

\*Soldered lead only

SKU	PRODUCT INCLUDES
DI-CPCHB-REC-48	<ul style="list-style-type: none"> <li>48 in. channel &amp; frosted cover</li> <li>End-caps: 1x open, 1x closed</li> </ul>
DI-CPCHB-REC-96	<ul style="list-style-type: none"> <li>96 in. channel &amp; frosted cover</li> <li>End-caps: 2x open, 2x closed</li> </ul>
DI-CPCHB-REC-ACC	<ul style="list-style-type: none"> <li>End caps: 2x open, 2x closed</li> <li>4x surface mounting clips</li> </ul>

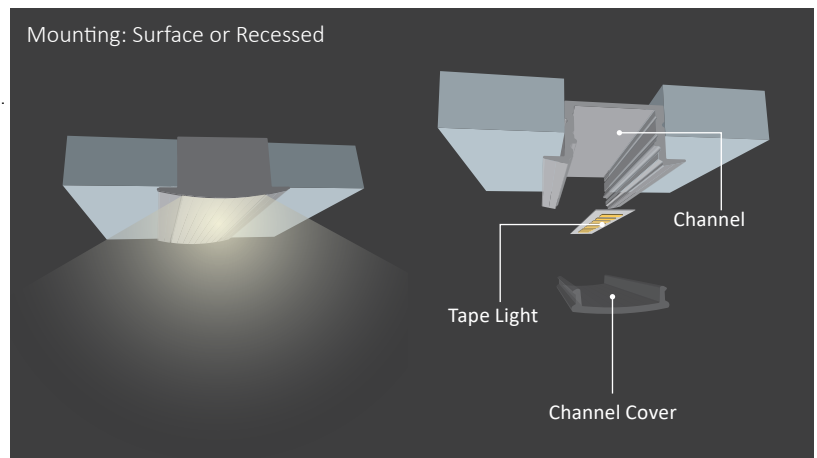

## CHANNEL BUNDLE DOME

### TAPE LIGHT COMPATIBILITY:

BLAZE™ \*DAZZLE® RGB  
BLAZE™ X \*DAZZLE® RGBW  
\*VALENT® X \*DAZZLE® RGBW 4D

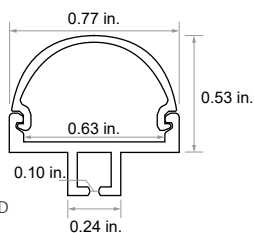

\*Soldered lead only

SKU	PRODUCT INCLUDES
DI-CPCHB-DOME-48	<ul style="list-style-type: none"> <li>48 in. channel &amp; frosted cover</li> <li>End caps: 1x open, 1x closed</li> <li>2x pendant hardware (39" L)</li> </ul>
DI-CPCHB-DOME-96	<ul style="list-style-type: none"> <li>96 in. channel &amp; frosted cover</li> <li>End caps: 2x open, 2x closed</li> <li>2x pendant hardware (39" L)</li> </ul>
DI-CPCHB-DOME-ACC	<ul style="list-style-type: none"> <li>End caps: 2x open, 2x closed</li> <li>2x pendant hardware (39" L)</li> </ul>

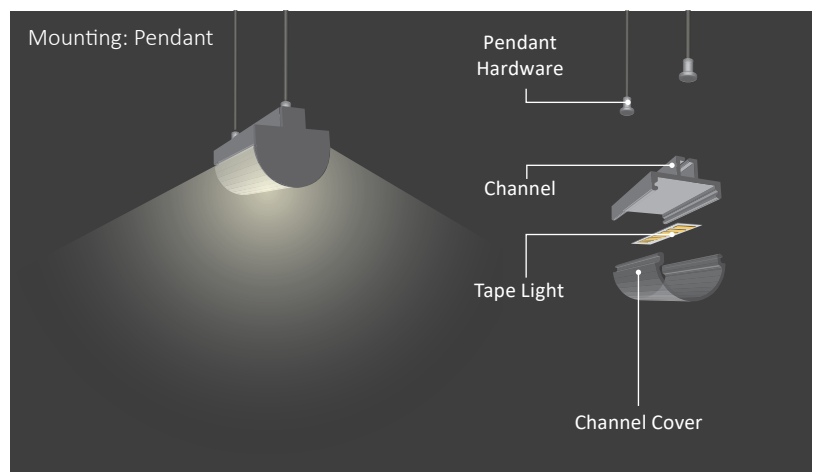

## CHANNEL BUNDLES

**NOTE:** Channel Bundles are **not** interchangeable with each other **nor** compatible with **Builder** channels.

### CHANNEL BUNDLE SCONCE

#### TAPE LIGHT COMPATIBILITY:

BLAZE™                      DAZZLE® RGB  
BLAZE™ X                  DAZZLE® RGBW  
VALENT® X

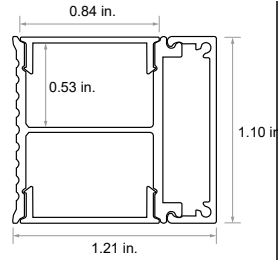

#### PREMIUM DIFFUSED TAPE LIGHT COMPATIBILITY:

Compatible tape light and channel eliminates LED hotspots by creating totally diffused linear light. See page 7 for details.

BLAZE™ BASICS      BLAZE™ X

SKU	PRODUCT INCLUDES
DI-CPCHB-SCNC-48	<ul style="list-style-type: none"> <li>48 in. channel &amp; mounting plate, 2x frosted covers</li> <li>End caps: 1x open, 1x closed</li> </ul>
DI-CPCHB-SCNC-96	<ul style="list-style-type: none"> <li>96 in. channel &amp; mounting plate, 2x frosted covers</li> <li>End caps: 1x open, 1x closed</li> </ul>
DI-CPCHB-SCNC-ACC	<ul style="list-style-type: none"> <li>End caps: 2x open, 2x closed</li> </ul>

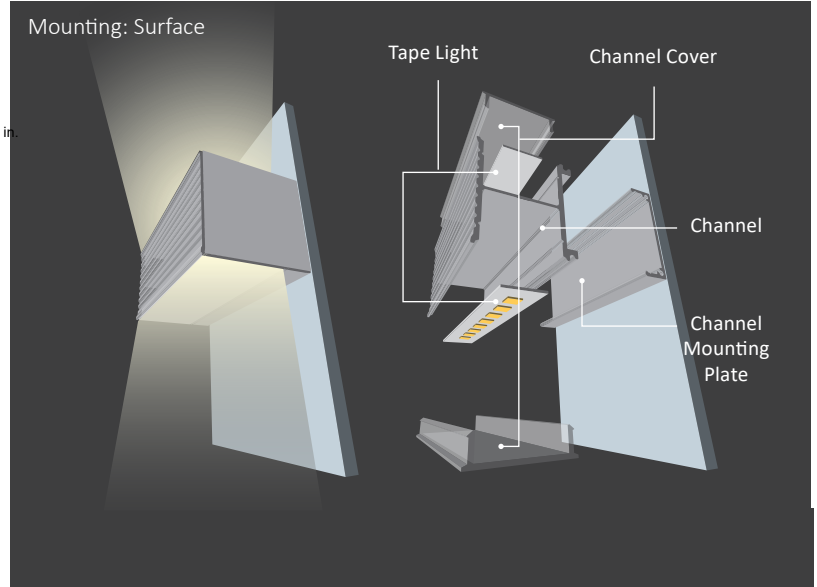

### CHANNEL BUNDLE 45° DECO

#### TAPE LIGHT COMPATIBILITY:

BLAZE™                      \*DAZZLE® RGB  
BLAZE™ X

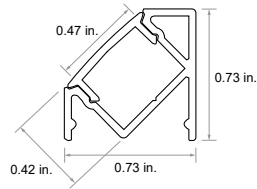

\*Soldered lead only

SKU	PRODUCT INCLUDES
DI-CPCHB-45DCO-48	<ul style="list-style-type: none"> <li>48 in. channel &amp; frosted cover</li> <li>End-caps: 1x open, 1x closed</li> <li>Mounting hardware</li> </ul>
DI-CPCHB-45DCO-96	<ul style="list-style-type: none"> <li>96 in. channel &amp; frosted cover</li> <li>End-caps: 2x open, 2x closed</li> <li>Mounting hardware</li> </ul>
DI-CPCHB-45DCO-ACC	<ul style="list-style-type: none"> <li>End caps: 2x open, 2x closed</li> <li>4x surface mounting clips</li> </ul>

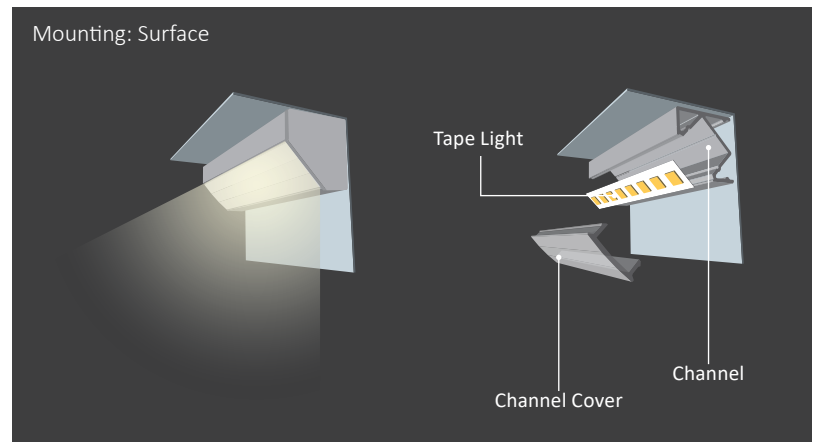

### CHANNEL BUNDLE 10mm ROUNDED CORNER

#### TAPE LIGHT COMPATIBILITY:

BLAZE™  
BLAZE™ X

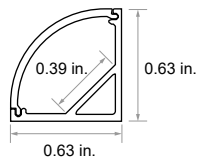

\*Soldered lead only

SKU	PRODUCT INCLUDES
DI-CPCHB-RC10-48	<ul style="list-style-type: none"> <li>48 in. channel &amp; frosted cover</li> <li>End-caps: 1x open, 1x closed</li> <li>Mounting hardware</li> </ul>
DI-CPCHB-RC10-96	<ul style="list-style-type: none"> <li>96 in. channel &amp; frosted cover</li> <li>End-caps: 2x open, 2x closed</li> <li>Mounting hardware</li> </ul>
DI-CPCHB-RC10-ACC	<ul style="list-style-type: none"> <li>End caps: 2x open, 2x closed</li> <li>4x surface mounting clips</li> </ul>

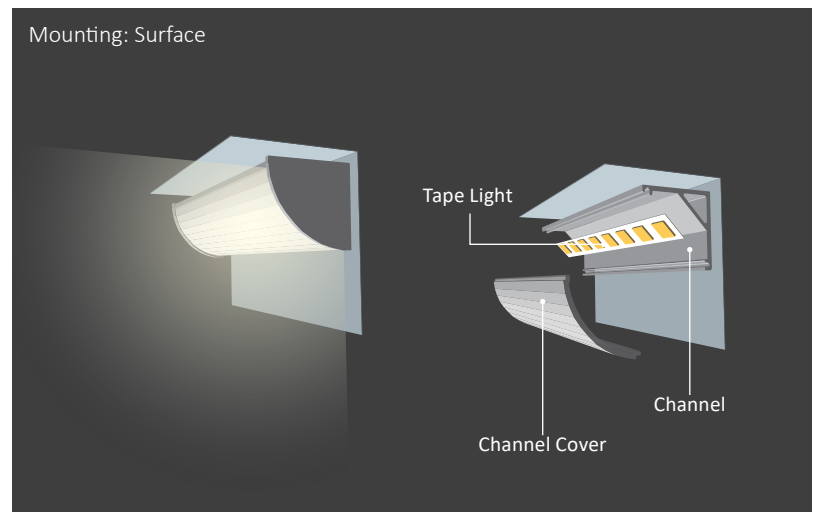

# CHANNEL BUNDLES

**NOTE:** Channel Bundles are **not** interchangeable with each other **nor** compatible with Builder channels.

## CHANNEL BUNDLE 10mm SQUARE CORNER

### TAPE LIGHT COMPATIBILITY:

BLAZE™ BASICS  
BLAZE™ X

\* Soldered leads only

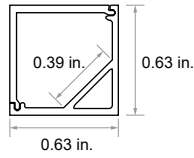

SKU	PRODUCT INCLUDES
DI-CPCHB-SQC10-48	<ul style="list-style-type: none"> <li>48 in. channel &amp; frosted cover</li> <li>End-caps: 1x open, 1x closed</li> <li>Mounting hardware</li> </ul>
DI-CPCHB-SQC10-96	<ul style="list-style-type: none"> <li>96 in. channel &amp; frosted cover</li> <li>End-caps: 2x open, 2x closed</li> <li>Mounting hardware</li> </ul>
DI-CPCHB-SQC10-ACC	<ul style="list-style-type: none"> <li>End caps: 2x open, 2x closed</li> <li>4x surface mounting clips</li> </ul>

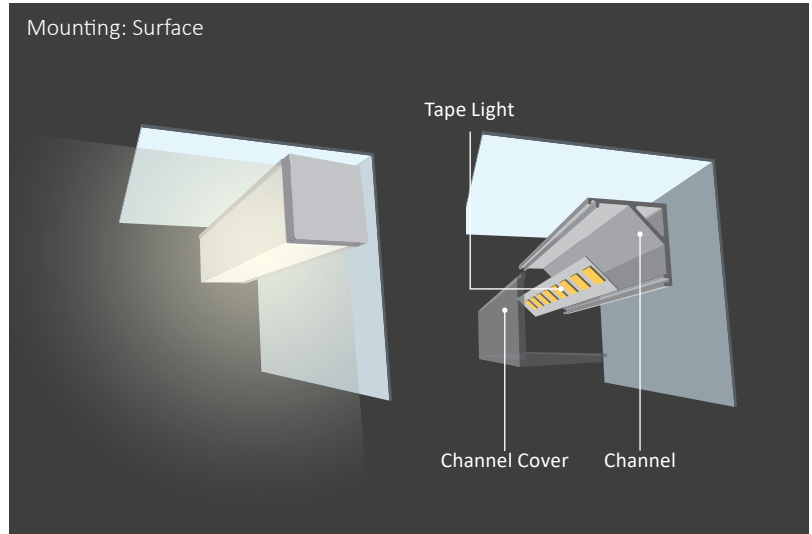

## CHANNEL BUNDLE 20mm ROUNDED CORNER

### PREMIUM DIFFUSED TAPE LIGHT COMPATIBILITY:

Compatible tape light and channel eliminates LED hotspots by creating totally diffused linear light. See page 7 for details.

BLAZE™                    DAZZLE® RGB  
BLAZE™ X                DAZZLE® RGBW  
VALENT® X              DAZZLE® RGBW 4D

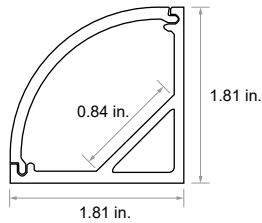

SKU	PRODUCT INCLUDES
DI-CPCHB-RC20-48	<ul style="list-style-type: none"> <li>48 in. channel &amp; frosted cover</li> <li>End-caps: 1x open, 1x closed</li> <li>Mounting hardware</li> </ul>
DI-CPCHB-RC20-96	<ul style="list-style-type: none"> <li>96 in. channel &amp; frosted cover</li> <li>End-caps: 2x open, 2x closed</li> <li>Mounting hardware</li> </ul>
DI-CPCHB-RC20-ACC	<ul style="list-style-type: none"> <li>End caps: 2x open, 2x closed</li> <li>4x surface mounting clips</li> </ul>

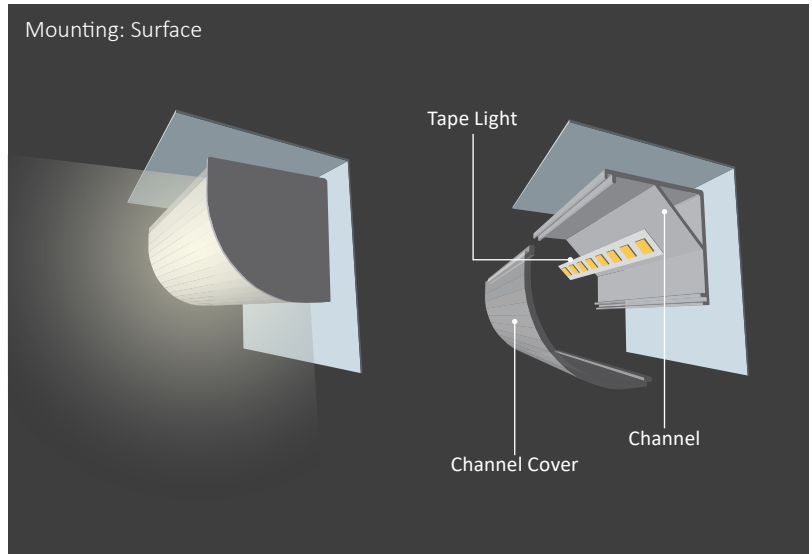

## CHANNEL BUNDLE 20mm SQUARE CORNER

### PREMIUM DIFFUSED TAPE LIGHT COMPATIBILITY:

Compatible tape light and channel eliminates LED hotspots by creating totally diffused linear light. See page 7 for details.

BLAZE™                    DAZZLE® RGB  
BLAZE™ X                DAZZLE® RGBW  
VALENT® X              DAZZLE® RGBW 4D

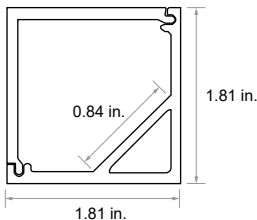

SKU	PRODUCT INCLUDES
DI-CPCHB-SQC20-48	<ul style="list-style-type: none"> <li>48 in. channel &amp; frosted cover</li> <li>End-caps: 1x open, 1x closed</li> <li>Mounting hardware</li> </ul>
DI-CPCHB-SQC20-96	<ul style="list-style-type: none"> <li>96 in. channel &amp; frosted cover</li> <li>End-caps: 2x open, 2x closed</li> <li>Mounting hardware</li> </ul>
DI-CPCHB-SQC20-ACC	<ul style="list-style-type: none"> <li>End caps: 2x open, 2x closed</li> <li>4x surface mounting clips</li> </ul>

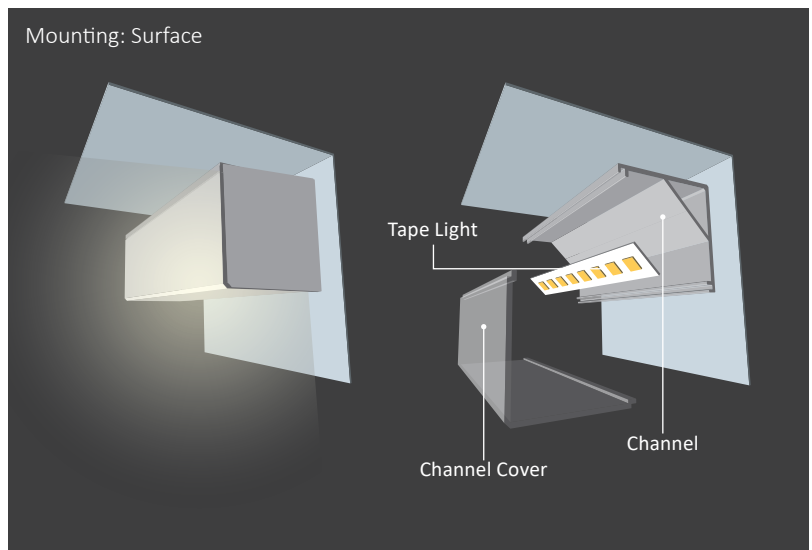

# CHANNEL BUNDLES

**NOTE:** Channel Bundles are **not** interchangeable with each other **nor** compatible with **Builder** channels.

## CHANNEL BUNDLE 90° SIDEVIEW

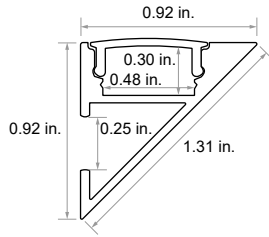

### TAPE LIGHT COMPATIBILITY:

BLAZE™ \*      \*DAZZLE® RGB  
BLAZE™ X

\*Soldered lead only

SKU	PRODUCT INCLUDES
DI-CPCHB-90SD-48	<ul style="list-style-type: none"> <li>48 in. channel &amp; frosted cover</li> <li>End-caps: 1x open, 1x closed</li> <li>Mounting hardware</li> </ul>
DI-CPCHB-90SD-96	<ul style="list-style-type: none"> <li>96 in. channel &amp; frosted cover</li> <li>End-caps: 2x open, 2x closed</li> <li>Mounting hardware</li> </ul>
DI-CPCHB-90SD-ACC	<ul style="list-style-type: none"> <li>End caps: 2x open, 2x closed</li> <li>4x surface mounting clips</li> </ul>

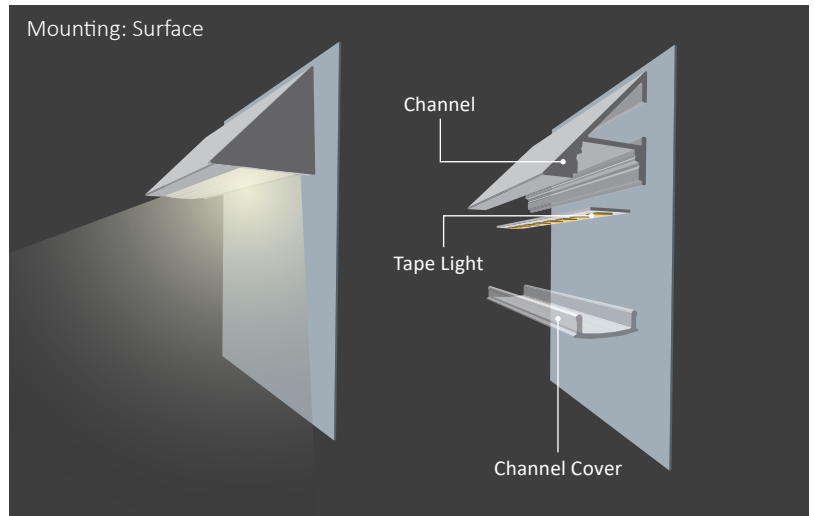

## CHANNEL BUNDLE WAVEFORM

### TAPE LIGHT COMPATIBILITY:

\*BLAZE™ \*      \*DAZZLE® RGB  
\*BLAZE™ X  
\*VALENT® X

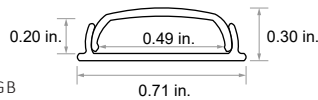

\*Soldered lead only

SKU	PRODUCT INCLUDES
DI-CPCHB-WF-48	<ul style="list-style-type: none"> <li>48 in. channel &amp; frosted cover</li> <li>End caps: 1x open, 1x closed</li> <li>2x mounting clips</li> </ul>
DI-CPCHB-WF-ACC	<ul style="list-style-type: none"> <li>End caps: 2x open, 2x closed</li> <li>4x mounting clips</li> </ul>

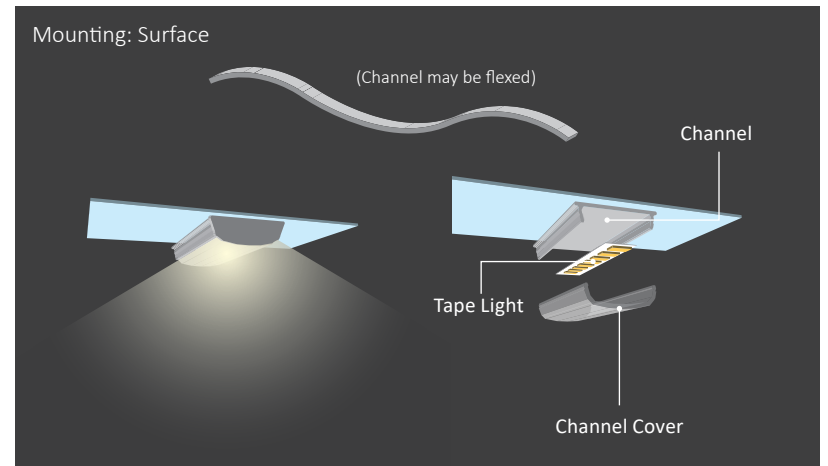

## CHANNEL BUNDLE SLIM RECESSED

### TAPE LIGHT COMPATIBILITY:

\*BLAZE™  
\*BLAZE™ X

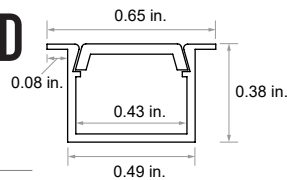

\*Soldered lead only

SKU	OPTION	INCLUDES
DI-CPCHB-SLR48	48 in. Bundle	<ul style="list-style-type: none"> <li>48 in. channel &amp; frosted cover</li> <li>End caps: 1x open square, 1x open round, 1x closed square.</li> </ul>
DI-CPCHB-SLR96	96 in. Bundle	<ul style="list-style-type: none"> <li>96 in. channel &amp; frosted cover</li> <li>End caps: 1x open square, 1x open round, 1x closed square.</li> </ul>
DI-CPEC-SLR-3	Additional End Cap Bundles	<ul style="list-style-type: none"> <li>3x open square, 3x open round, 3x closed square</li> </ul>

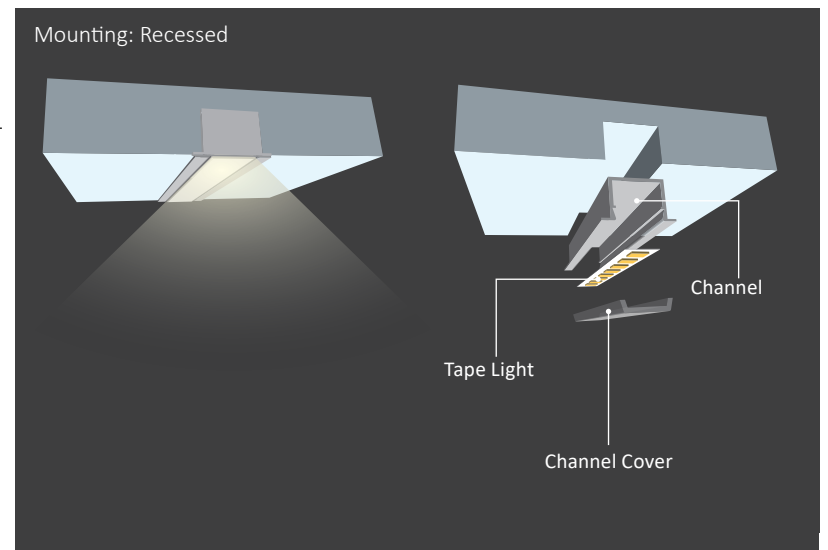

# CHANNEL BUNDLES

**NOTE:** Channel Bundles are **not** interchangeable with each other **nor** compatible with **Builder** channels.

## CHANNEL BUNDLE REFLECTOR

### TAPE LIGHT COMPATIBILITY:

- \*BLAZE™
- \*BLAZE™ X
- \*VALENT® X
- \*DAZZLE® RGB
- \*DAZZLE® RGBW

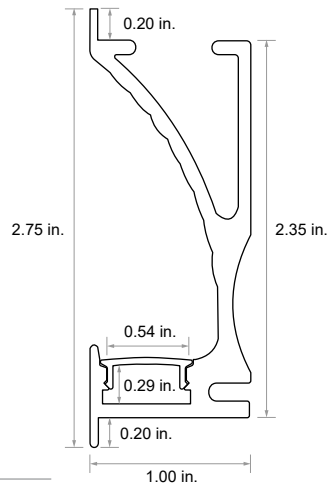

\*Soldered lead only

SKU	PRODUCT INCLUDES
DI-CPCHB-RFCTR-48	<ul style="list-style-type: none"> <li>• 48 in. channel &amp; frosted cover</li> <li>• End caps. 1x open, 1x closed</li> </ul>
DI-CPCHB-RFCTR-96	<ul style="list-style-type: none"> <li>• 96 in. channel &amp; frosted cover</li> <li>• End caps. 1x open, 1x closed</li> </ul>
DI-CPCHB-RFCTR-ACC	<ul style="list-style-type: none"> <li>• End caps: 2x open, 2x closed</li> </ul>

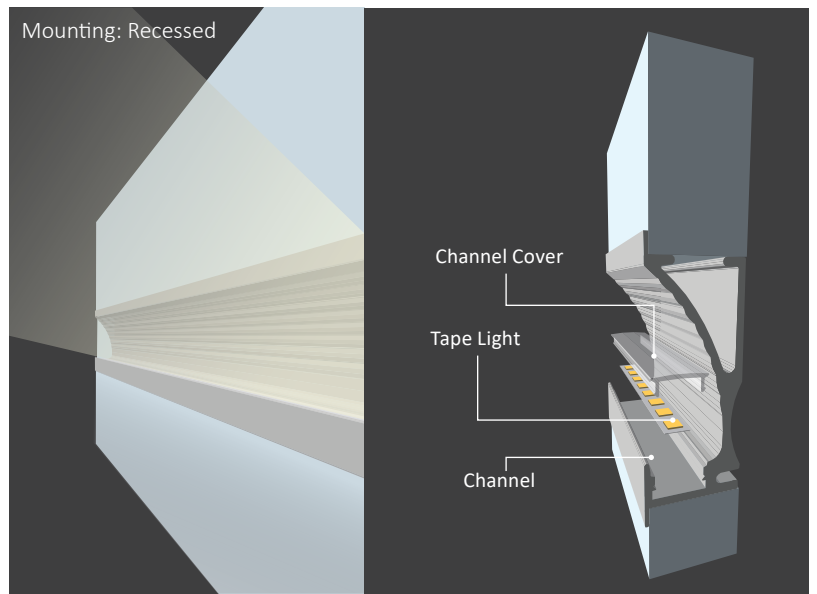

## ADDITIONAL RESOURCES

BUILDER CHANNELS SPEC SHEET

ALUMINUM CHANNEL INSTALL GUIDE

VERTICAL MOUNTING BRACKET INSTALL GUIDE

LOW VOLTAGE TAPE LIGHT SPECIFICATION SHEETS

LOW VOLTAGE LED TAPE LIGHT INSTALL GUIDE

VALENT® X SPEC SHEET

## SAFETY / WARNINGS / DISCLOSURES

1. Install in accordance with national and local electrical code regulations.
2. Do not modify or disassemble this product beyond instructions or the warranty will be void.
3. Mixing and matching finished hardware and accessories can result in loose or tight fit assemblies. We strongly recommend matching hardware and endcaps to the channel finish selected.
4. Actual color may vary from what is pictured on this sheet and other print materials due to the limitations of photographic processes.
5. We reserve the right to modify and improve the design of our fixtures without prior notice. We cannot guarantee to match existing installed fixtures for subsequent orders or replacements in regards to product appearance, CCT, or lumen output.

## WARRANTY

### Limited Warranty

This product has a five (5) year limited warranty from the date of shipment. This warranty does not include the additional accessories referenced in this specification sheet. Complete warranty details for fixtures and additional accessories are available at [www.diodeled.com/limited-warranty/](http://www.diodeled.com/limited-warranty/) within the Policies section. For warranty related questions please contact product support.

### Consumer's Acknowledgment

Elemental LED, Inc. stands behind its products when they are used properly and according to our specifications. By purchasing our products, the purchaser agrees and acknowledges that lighting design, configuration and installation is a complex process, wherein seemingly minor factors or changes in layout and infield adjustments can have a significant impact on an entire system. Choosing the correct components is essential. Elemental LED is able to work with the original purchaser to make an appropriate product selection to the extent of the limited information that the customer can provide, but it is virtually impossible for Elemental LED to design a system that foresees every unknown factor. For this reason, this Warranty does not cover problems caused by improper design, configuration or installation issues. Any statement from a Elemental LED employee or agent regarding a customer's bill of goods and/or purchase order is NOT an acknowledgment that the products purchased are designed and configured correctly. The purchase agrees and acknowledges that it is the customer's responsibility to adhere strictly to all information contained in the Product Specification Sheets.

There is often more than one way to design, configure and layout an LED lighting application properly to achieve the same lighting effect. Elemental LED strongly recommends that licensed professionals be used in the design and installation of lighting systems that include Elemental LED products. The specifications include important information that a designer and installer should carefully review and strictly follow. Qualified designers and certified and/or licensed installers, with access to the final installation environment, customer goals, and Elemental LED product specifications can make the requisite decisions appropriate for a successful finished lighting application.

